

Microstove









FREESTANDING ELECTRIC STOVE

MCFSTV12E



Microstove

Features

-  Unique Optiflame effect
-  1.2kW heat output
-  Choice of 2 heat settings
-  Thermostat
-  LED lighting
-  Manual control
-  Log effect fuel bed
-  Flame effect only
-  Freestanding

Microstove



Microstove

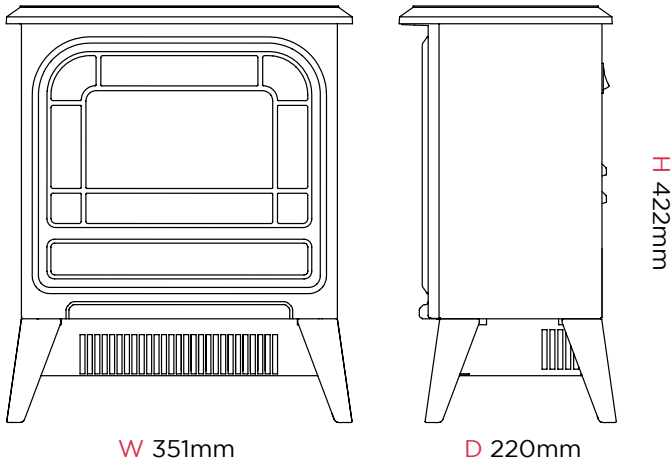

Dimensions & Weight

Height (mm)	Width (mm)	Depth (mm)	Weight (kg)
422	351	220	6

Product Features

Product Category	Electric Fires
Product Type	Stove
Brand	Dimplex
Model/Range Name	Microstove
Flame Effect	Optiflame
Model Reference	MCFSTV12E
Material Code	X-061522
Barcode	5011139061522
Commodity Code	8516299100
Country of Origin	PRC
Approvals	UKCA, BEAB
Guarantee Period	1 year

Product Features

Heat Output	1.2kW
Heat Settings	600W / 1.2kW
Variable Thermostat	Y
Fan Heat / Radiant Heat	Yes / No
Location of Controls	Back of product
On/Off Switch	Y
Remote Control	N
Batteries Included	N/A
Optiflame Effect	Y
Flame Type	Optiflame
Flame Effect Only	Y
Fuel Bed Supplied	Logs

Product Features

Lot 20 Compliant	Y
Freestanding	Y
Wall Mountable	N
Inset	N
Opening Door	N
Suite	N
Lamp Type	LED
Kettle (IEC) Lead	N
Safety Cut Out	Y
Power Cord Length	1.8m
Core Materials	Metal / Plastic
Finish / Colour	Black

Accessories

HPD001 Hearth Pad	X-025951
-------------------	----------