

**The COMET Range of Boilers**  
the ultimate solution for central heating

**INSTALLATION  
&  
TECHNICAL MANUAL**



**If you require any further assistance:**

**Telephone: 01698 820533**

**Fax: 01698 825697**

**E-mail: [info@electric-heatingcompany.co.uk](mailto:info@electric-heatingcompany.co.uk)  
or visit our website [www.electric-heatingcompany.co.uk](http://www.electric-heatingcompany.co.uk)**

## Contents

Explanation of symbols	3
Target group	3
Safety Guidelines	4
Safety Guidelines (cont.)	5
Product overview	5
Intended use	5
Product highlights	5
Construction	6
Assembly and installation	7
Installation notes	8
Boiler configuration	11
Connection of external control signals	12
External Control Wiring Methods	14
Necessary steps involving initial commissioning	18
Control panel	19
Technical data	33
Product disassembly	35
Packaging contents	35
Optional Accessories	35
Maintenance	35
Warranty Terms & Conditions	36
Packaging disposal	37
Declaration of conformity; reference standards and directives	37

## Introduction

Please read and follow the installation and operating instructions carefully, to ensure the long life and reliable operation of this appliance.

The Electric Heating Company may make minor changes if necessary in the appliance that will not be shown in the operating instructions, so long as the main features of the boiler remain the same.

All boilers come with a 24 month warranty that covers all defects originating from faulty materials and workmanship in the manufacture. For further details please refer to the warranty section within this document.

The boiler requires to be registered by the installer or home owner by scanning the smart tag located on the front of the boiler or alternatively on the Electric Heating Company website, [www.electric-heatingcompany.co.uk](http://www.electric-heatingcompany.co.uk)

**A Magnetic Filter Must Be Fitted To This Boiler, Failure To Protect The System Will Invalidate the Manufacturer's Warranty.**

## Explanation of symbols

---



Follow the safety instructions carefully in order to prevent injury and damage.



**Danger**  
This sign warns against danger of injury.



**Note**  
This sign warns against property damage and environmental pollution.

*Tip*

*Text marked with the word Tip contains additional information.*



Refer to this manual when operating the product or its controls labelled with this symbol.

## Target group

---



This manual is intended for the users of the product. This product can be operated by children at least 3 years old and individuals with impaired physical, sensory or mental capacity, or unexperienced and/or not knowledgeable in operation of the product only if instructed about its safe operation and understand all hazards involved. This product is not a toy for children. Children may only clean and maintain this product under supervision of an adult.

- Only qualified electricians may service electrical components.
- The first commission of this product for operation shall be done by the installer or a designated individual with suitable authorisation.

---

### **This appliance must be fitted in accordance with the following instructions.**

- The Building Regulations
- The Building Standards, (Scotland-consolidated) Regulations.
- Local water bylaws. British Standards- code of practice

#### **BS EN 12828**

Heating systems in buildings. Design for water-based heating systems.

#### **BS EN 12831**

Heating systems in buildings. Method for calculation of the design heat load.

#### **BS EN 14336**

Heating systems in buildings. Installation and commissioning of water based heating systems.

#### **BS7671**

Requirements for electrical installations. IEE Wiring Regulations.

#### **BS EN 13831**

Closed expansion vessels with built-in diaphragm for installation in water.

## Safety Guidelines

---

1. Familiarizing yourself with the contents of this instruction manual will enable proper installation and operation of the device, ensuring its long-lasting and reliable performance.
2. No isolation valves should be installed on the discharge of the safety valve mounted in the boiler. A drain funnel, which is included with the device, may be installed as shown in the drawing.
3. The device is intended exclusively for installation on a flat wall.
4. The device must not be installed in damp spaces, areas at risk of explosion, or where the ambient temperature may drop below 0°C.
5. Boiler installation, as well as the execution of the electrical and hydraulic installations, should be entrusted to a specialized service company and strictly follow the product's installation and operating instructions.
6. All installation work must be carried out with the electricity and water supply turned off.
7. The electrical installation should be equipped with residual-current protective devices and means to disconnect the device from the power source, in which the distance between the contacts of all poles is not less than 3mm.
8. The boiler is sensitive to surges; therefore, the electrical installation must include surge protection devices.
9. The boiler's electrical supply point must imperatively have up-to-date testing confirmed by a protocol.
10. Water should not be drained from the central heating (CH) installation after the heating season has ended.
11. During the break between heating seasons, the controller should be left in standby mode and the electric supply to the boiler should not be disconnected. This will reduce power consumption to a minimum. Failure to follow this recommendation may cause the circulating pump's impeller to lock.

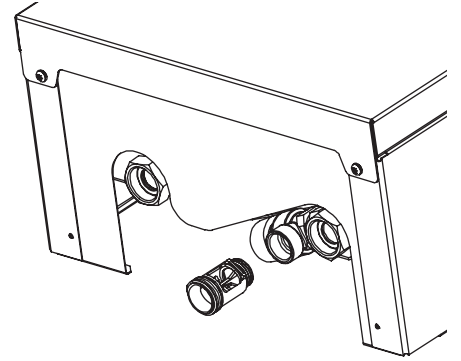

### **Danger**

**Incorrectly performed connection work can lead to life-threatening accidents. Work on the devices can only be carried out by a qualified installer.**

## Working with this product

1. The device should be installed in accordance with national installation regulations.
2. The electrical installation should be performed in accordance with the BS 7671 standard, it should be operational at the time of startup and during use.
3. The heating installation equipped with a diaphragm expansion vessel in accordance with: BS EN 12828, BS 6700 and CP 342-2 - closed system.
4. The heating system must be thoroughly flushed before installing the boiler.



### **Note**

The device can only be used when it has been properly installed and is in impeccable technical condition.

## Safety Guidelines (cont.)

---

### Operation of the product

 **Danger**  
All installation, service, and maintenance work should be performed with the electricity and water supply turned off.

 **Danger**  
Do not open the boiler casing with the power on.

 **Danger**  
Incorrectly performed connection work can lead to life-threatening accidents. Work on the devices can only be carried out by a qualified installer.

### Product overview

---

The Electric Central Heating Boiler types are designed for heating residential spaces equipped with underfloor heating systems using water or antifreeze as the heat transfer medium. The boiler should be selected based on the thermal heat loss of the building.

The boiler belongs to low-temperature types, operating in closed-loop water heating systems with forced water circulation, secured in accordance with the standard. It can also operate in open-loop water heating systems with forced water circulation, secured in accordance with the standard.

The boiler operates in an automatic cycle with minimal operational tasks.

### Intended use

---

The device is intended solely for domestic or similar use. Commercial or industrial use leading to excessive operation of the device is inconsistent with its intended purpose.

Improper use of the device, or unprofessional handling, is prohibited and results in the manufacturer's liability being voided. Improper use also includes changing the intended function of the heating system components.

#### Tip

*The device is designed exclusively for domestic or light commercial use, meaning that even untrained individuals can safely operate it.*

### Product highlights

---

The device has been equipped with a range of safety features to protect it from malfunctions caused by central heating installation issues, such as:

- water flow control system
- internal temperature regulator
- thermal switch
- safety valve

The boiler is equipped with: a circulating pump, a pressure sensor, a diaphragm expansion tank (applies only to EKCO.MN3), an automatic air vent, and a safety valve.

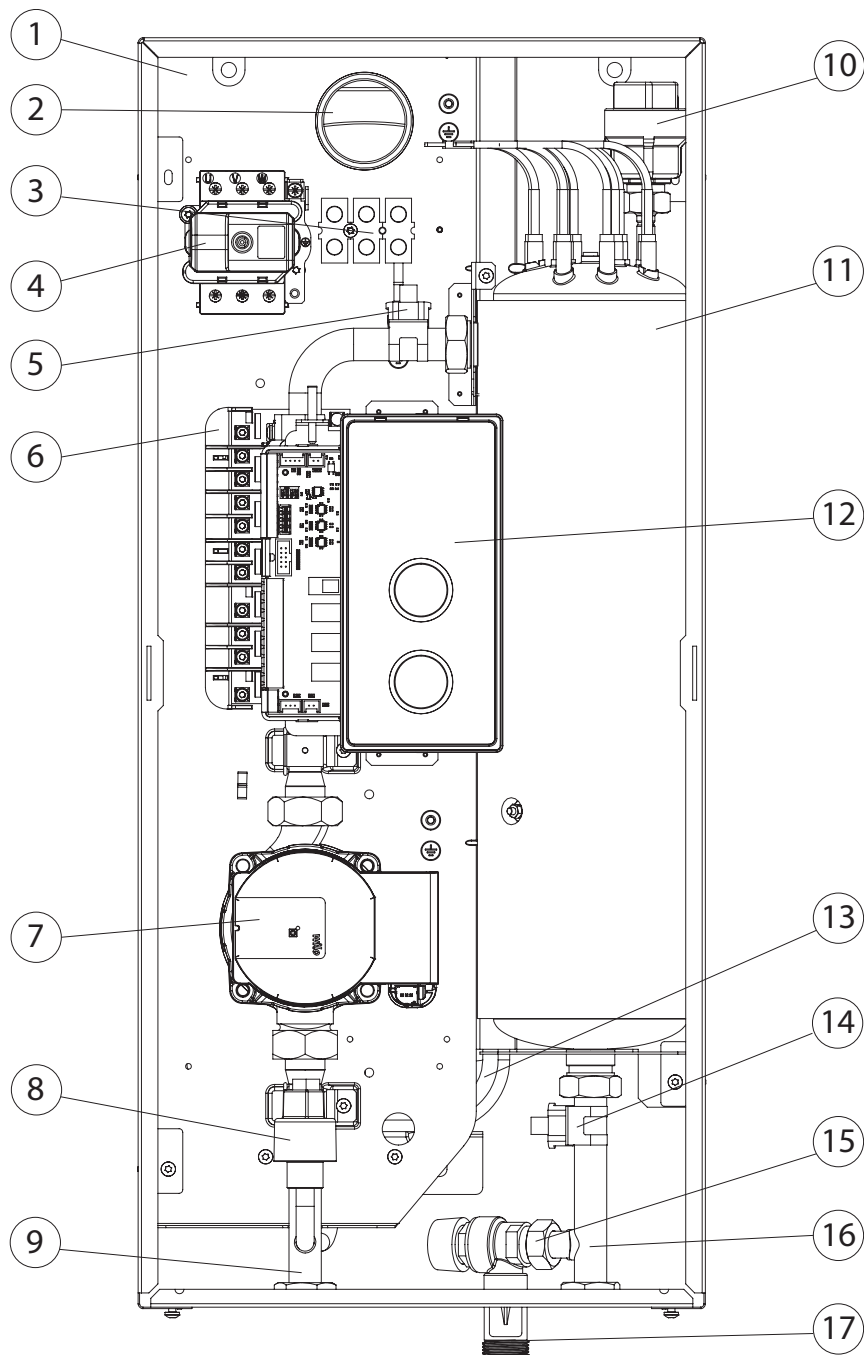

- [1] - base
- [2] - hole for the introduction of the electric power cable
- [3] - terminal strip
- [4] - thermal cutoff switch
- [5] - boiler inlet temperature sensor
- [6] - power unit
- [7] - circulating pump
- [8] - pressure sensor
- [9] - inlet connection
- [10] - automatic air vent
- [11] - heating assembly
- [12] - control panel
- [13] - diaphragm expansion vessel (pertains to EKCO.MN3 boiler)
- [14] - boiler outlet temperature sensor
- [15] - safety valve
- [16] - outlet switch
- [17] - drain funnel



## Installation notes

Comet PV boilers are equipped with an expansion vessel (capacity: 5l, pressure: 1,5 bar). The expansion vessel is sufficient for the following capacities of heating system at given temperatures of the medium and central heating system pressure.

Temperature of heating medium (feed and return) [°C]	Capacity of central heating system [l]	Pressure in central heating system [bar]
85/70	56	1,5
70/55	80	
55/45	127	
50/40	153	
45/35	188	

If the capacity of the wet central heating installation is larger, an extra expansion vessel should be installed as applicable in accordance with system volume.

### Boiler connection to the central heating system

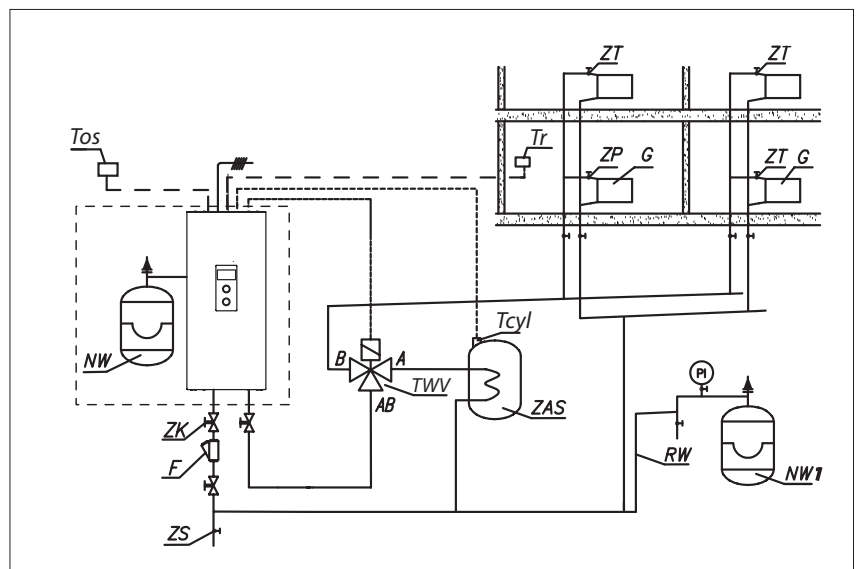
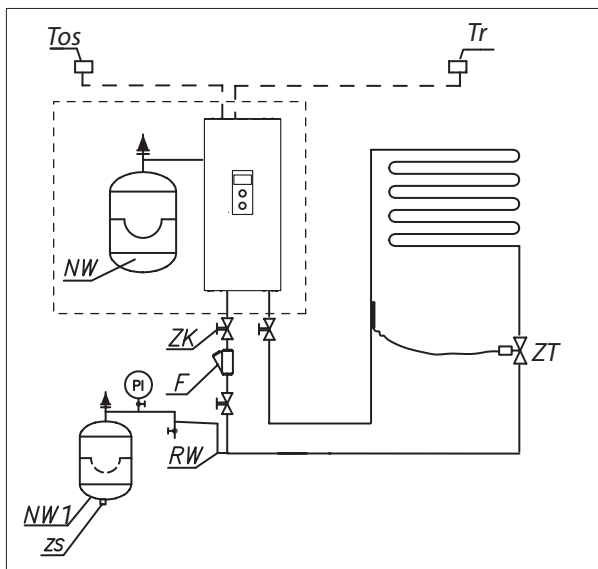

PI - manometer  
 ZK - cut-off valve  
 RW - expansion pipe  
 NW - built-in expansion vessel  
 NW1 - expansion vessel  
 ZT - thermostatic valve  
 ZP - passage valve  
 F - filter

G - radiator  
 ZS - drain valve  
 TWV - three-way valve  
 ZAS - DHW Cylinder  
 Tr - regulator of room temperature  
 Tcyl - DHW cylinder temperature sensor  
 Tos - outside temp. sensor

All boiler installations must include a magnetic filter and local isolation of the boiler should be provided by the means of full bore lever ball valves.



#### Note

A Magnetic Filter Must Be Fitted To This Boiler, Failure To Protect The System Will Invalidate the Manufacturer's Warranty.



## Connection diagrams of boilers to the electrical installation

Depending on the model of purchased boiler and the electrical installation on site, the boiler should be connected in accordance with the drawings below.

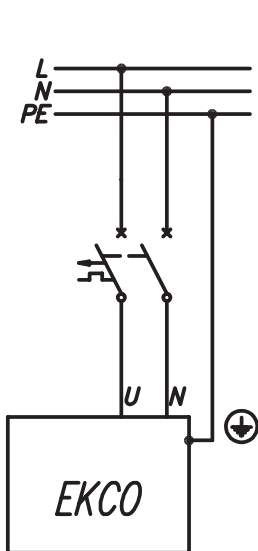

2, 4, 6, 8 kW 230V 1N~  
7, 9, 11, 14 kW 230V 1N~

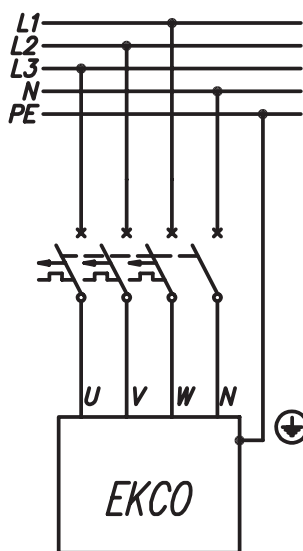

12, 16, 20, 24kW 400V 3N~

### Single phase connection 230V 1N~

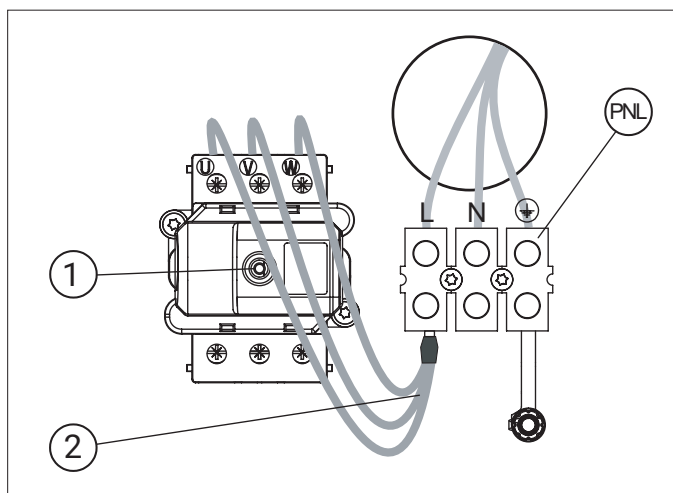

### Three phase connection 400V 3N~

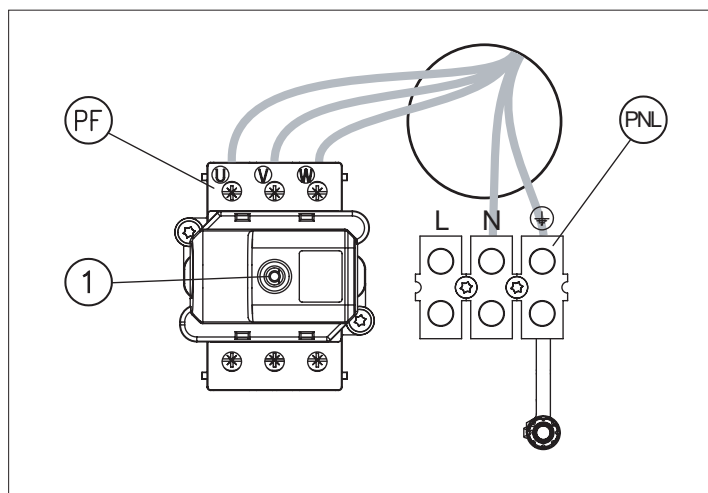

*PNL* - connection points of neutral, protective and phase conductors

[1] - temperature limiter

[2] - additional conductors  
(for one-phase system only)

*PNL* - points of neutral and protective conductor connection

*PF* - points of phase conductors connection

[1] - temperature limiter

## ELECTRIC CONNECTION

The electricity connection of the boiler must be made by a qualified electrician. Improper electrical connections made by unqualified people may cause failure of critical components of the boiler and will invalidate the warranty.



### **Danger**

**Electric Shock Risk. Make sure to isolate the main energy supply before starting to work on the boiler. Secure the main energy supply to prevent from accidental switch on while working on the boiler.**

### **Electricity Connection Precautions**

All wiring must be carried out in accordance with current wiring regulations BS7671.

All electrical connections must be made by a qualified electrician.

We recommend that a load check is carried out when installing high power boilers. This must be done by a qualified electrician.

Upgrading the main fuse of the property may be required.

A proper earth connection must be made before operating the boiler.

### **Electricity Supply Connection**

The main electrical cable supplying the boiler should be protected by a 30mA Residual Current Device (RCD).

Where possible it is recommended to supply the boiler and associated circuits from a dedicated distribution board to prevent overload of the current domestic distribution board.

If an electric shower is present we recommend that a Shower Sensor is installed within the system to each shower and connected to the MA terminal within the boiler. This will cause an interrupt to the boilers control signal when the shower is in use. It will disable the boiler protecting the electrical system from overload. EHC part code is ESFS15C



Local isolation is required to be installed adjacent to the boiler by means of a rotary isolator suitably rated for the boiler capacity.

If the property is supplied by a rural power supply or prone to lightening strikes & power cuts it is recommended to install a suitable surge protection device to the boiler supply. This will reduce the risk of damage to the boiler electronics during these events.



The boiler supply cable should be calculated by the means of a cable calculation in accordance with BS7671 by a suitably qualified electrician with reference to the technical table within this manual.

## Boiler configuration

Before turning on the power ensure that the switch settings are in compatible configuration with the boiler's model and the type of installation.

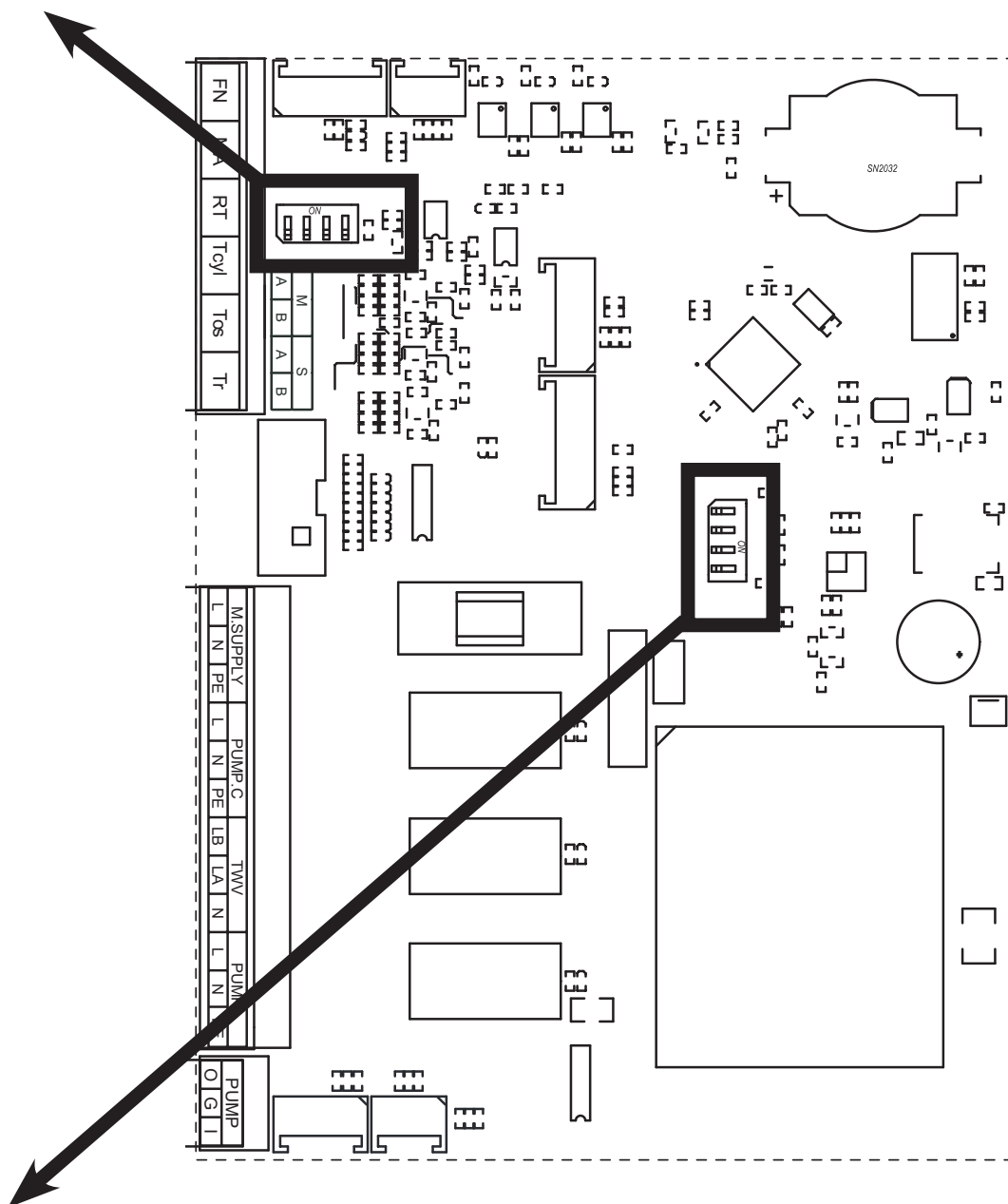
Switch setting	Rated power and type of installation	
 1 - OFF 2 - OFF 3 - OFF	12 / 16/ 20 / 24 kW, three phase 400V 3N~	
 1 - OFF 2 - ON 3 - OFF	2 / 4 / 6 / 8 kW, single phase 230V 1N~	
 1 - ON 2 - OFF 3 - ON	7,2 / 9,6 / 12,0 / 14,4 kW, single phase 240V~	



Switch setting	Function	
 1 - ON 2 - OFF	Comet PV boiler in stand-alone mode or master in cascade operation	
 1 - OFF 2 - OFF	Comet PV slave boiler in cascade operation mode (Comet PV.S)	

## Connection of external control signals

**!** **Note**  
Do not connect any voltage into FN, MA, RT, Tcyl, Tos, Tr entries! This can result in permanent controller damage.

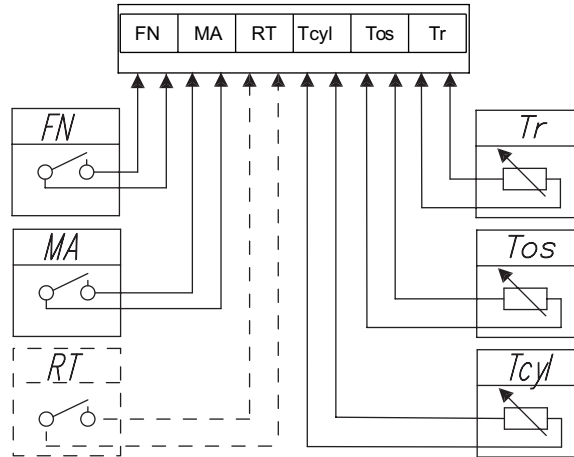

Entry symbol	Function
<b>FN</b>	External forcing of temperature change or work algorithm [ <i>Configuration&gt;Entry FN</i> ].
<b>MA</b>	In order to limit the power used, i.e. the boiler can cooperate with other appliances such as an electric water heater. In order to do so, an electrician should install in line an extra open contact to the MA entry, so that when a master appliance gets on, the contact opens, and the boiler switches off- it results in heating blockage and pump's standstill.
<b>RT</b>	Optional control of the boiler operation by an external temperature controller. The RT input should be activated [ <i>Configuration&gt;Room temp.&gt;Temp. sensor: RT</i> ]. Short-circuiting the potential-free contact will cause the central heating installation to turn on. When the RT input is activated, the functions of the internal room controller will be disabled, including the timer, and if the CH configuration is set to the heating curve, it will be adjusted (set) to a temperature of 22 degrees Celsius.
<b>Tcyl</b>	DHW cylinder temperature sensor. Optionally, it can be replaced with an external contact thermostat. To do this, activate the external DHW thermostat. [ <i>Configuration&gt;DHW cylinder&gt;Regulation: Outside</i> ]. Short circuit of the Tcyl input will result in switching on the DHW cylinder heating. When an external DHW regulator is activated., the built-in functions of timer and temperature regulator will not be available.
<b>Tos</b>	Outside temperature sensor (Tos). It should be installed in a shaded place, on the north or north-west facade of the building, away from windows and ventilators.
<b>Tr</b>	Room temperature sensor (Tr). It should be installed in a representative location of the facility, away from heaters, windows, doors and communication routes.

## Communication bus RS485

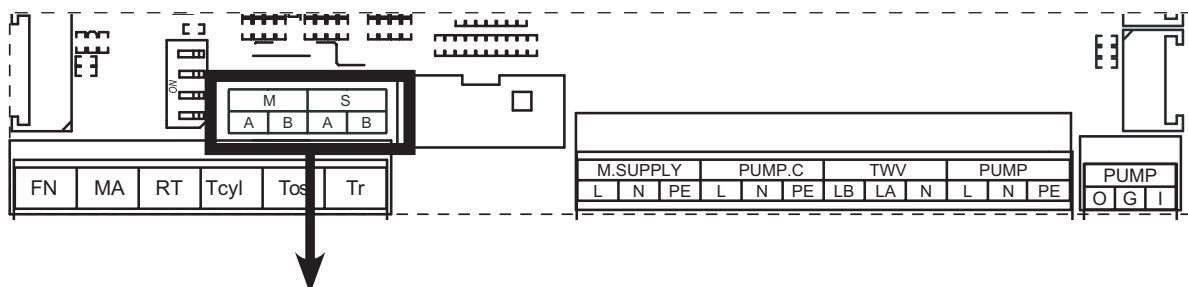

Entry symbol	Entry functions
<b>S</b>	<ul style="list-style-type: none"> <li>• Connection point for the C.MI2 internet module for a boiler in stand-alone mode or for the master boiler in cascade operation mode.</li> <li>• Connection point with the master boiler for a slave boiler in cascade operation mode.</li> </ul>
<b>M</b>	<ul style="list-style-type: none"> <li>• connection point for C.MG3 heating modules and boilers in subordinate mode operation.</li> </ul>

## Connecting external devices via communication bus

Internet Module C.MI2, boiler cascade

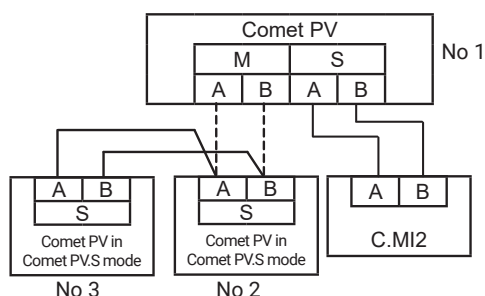

EKCO.M3 boiler, C.MG3 heating module, and C.MI2 internet module

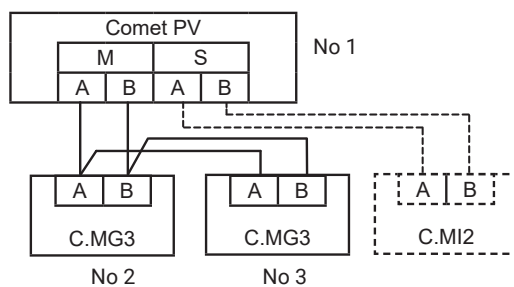

Cascade connection of boilers

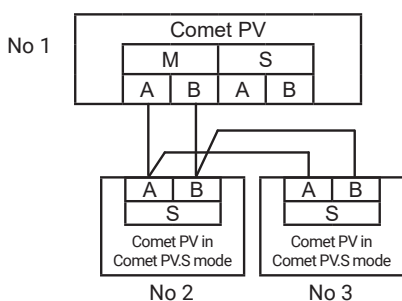

Internet module C.MI2, heating module C.MG3, slave boiler in cascade mode

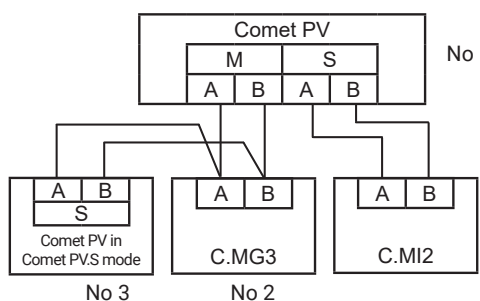

### Note

Each of the devices connected to the communication bus must be assigned a unique identification number (this does not apply to C.MI2). The maximum number of devices that can be configured in the system is 32.

## Connection of actuators

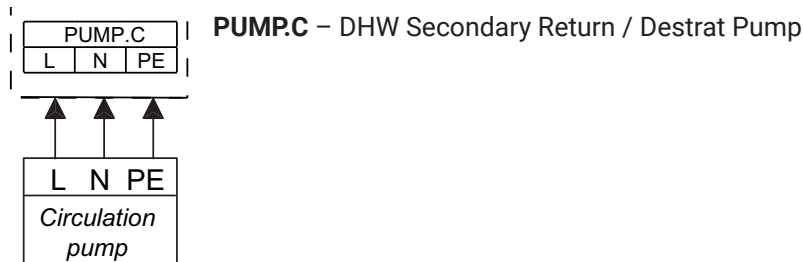

## TWV - three-way valve connection

Depending on the type of drive control (3 Port or 2x 2 Port), you should choose the appropriate valve connection diagram and configure the valve control accordingly [Configuration>DHW cylinder>Control: A-CH B-DHW / A-DHW B-CH].

### SPDT

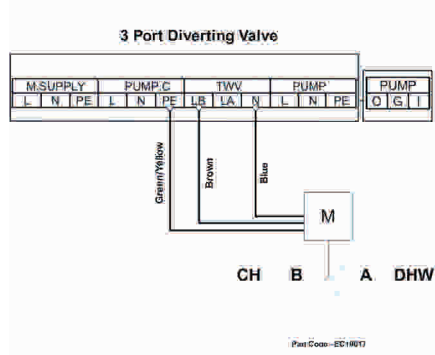

### SPST

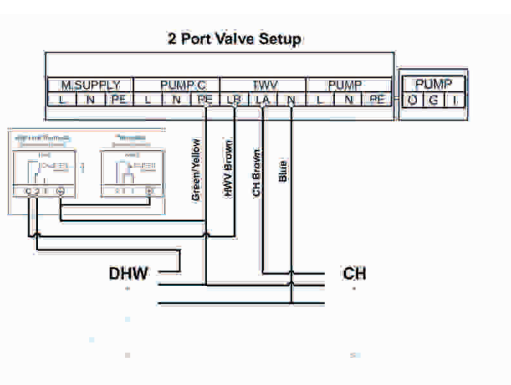

### A drawing depicting the control logic of the TWV valve in the controller

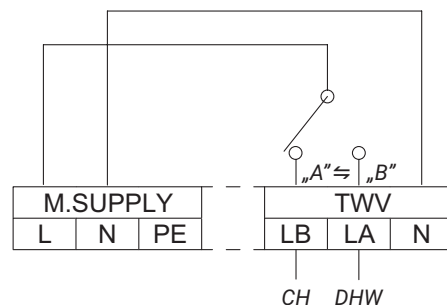

## **External Control Wiring Methods**

---

The Comet PV Smart boiler can be wired in various configurations to suit the needs of the customer and installation as described below.

### **Smart Boiler Wiring;**

To experience all the Comet PV boiler has to offer we recommend that the Comet PV boiler is wired as per the “Smart Boiler Wiring Diagram” in order to take full advantage of the boilers features and achieve optimum system efficiency. When wired in accordance with the smart wiring diagram the boiler takes full control of the system via the user friendly control panel with no requirement for external 3rd party controls. The boiler can also be controlled remotely via smart app when connected to the C.MI2 Internet Smart Module (Partcode: AHP1004) which is sold separately. This mode can also operate multiple heating zones which can be individually controlled from the boilers control panel or the smart app interface when using the C.MG3 Heating Zone Control Module (Partcode EC10018).

### **Hybrid Wiring;**

IF the Comet boiler is wired using the Hybrid wiring method hot water priority and weather compensation can still be utilised however the boiler can no longer Control Room temperature or Domestic Hot Water temperature from the boiler display. Central Heating can be controlled via the use of 3rd party controls connected to the RT terminal and the DHW tank temperature is regulated by the mechanical cylinder thermostat. In hybrid mode the Room temperature sensor settings should be set to RT and the DHW regulation type set to “Outside” within the configuration menu.

### **Standard S-Plan & Heating Only**

The Comet PV Boiler comes packed with smart features however these features can be deactivated in order for the boiler to operate in a standard way via the command of external zone valves and controls. When wired with an external S-Plan configuration the valves will trigger the boiler to heat when the grey and orange wires of the valves are connected to the RT terminal (RT is volt free only). When wired in this method the boiler will remain in Heating Only mode. It is also important to deactivate weather compensation within the configuration menu and manually set the required system temperature when heating a hot water cylinder.

# Smart Boiler Control Wiring

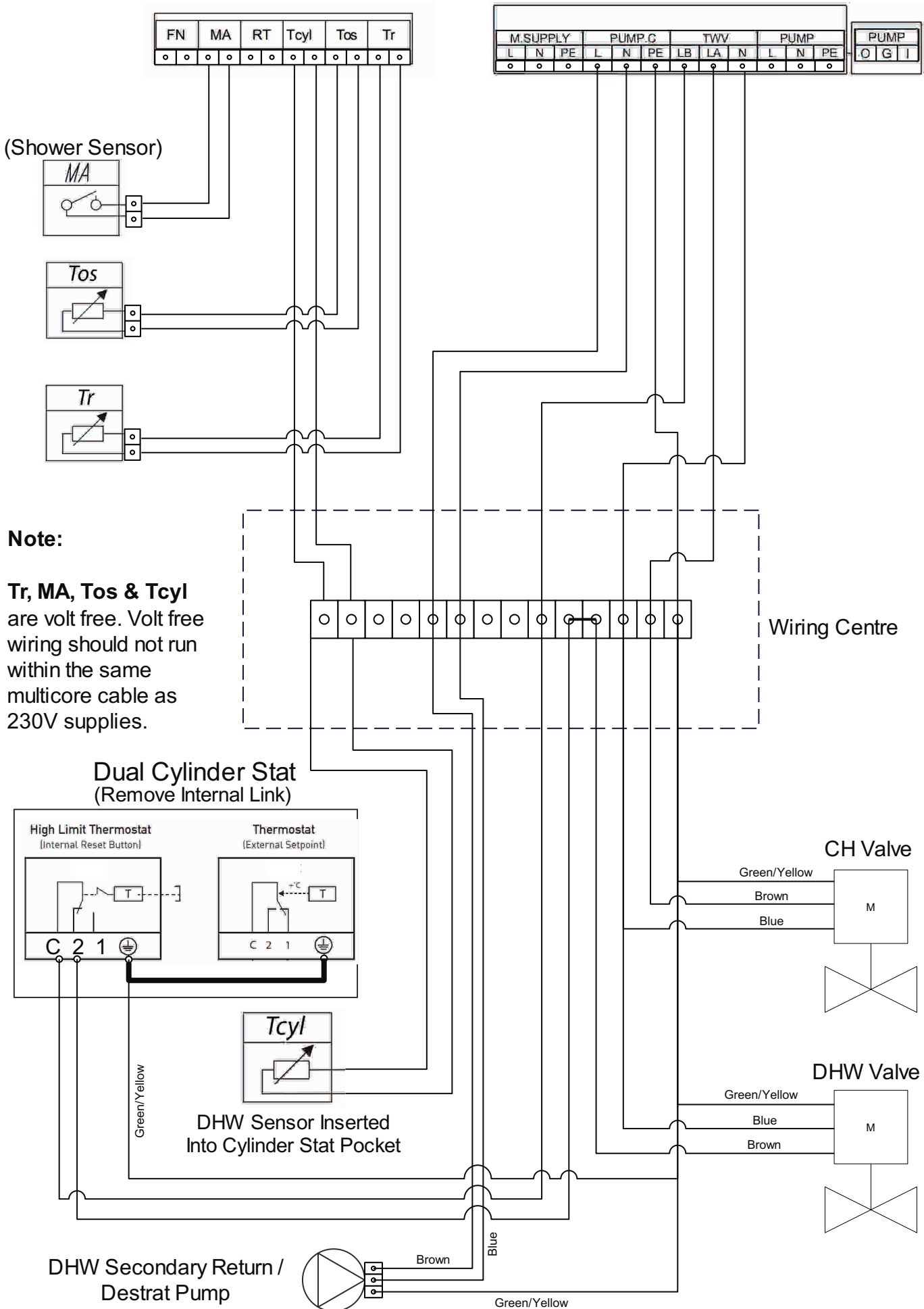

# Hybrid Control Wiring

## (Heating & Priority Hot Water)

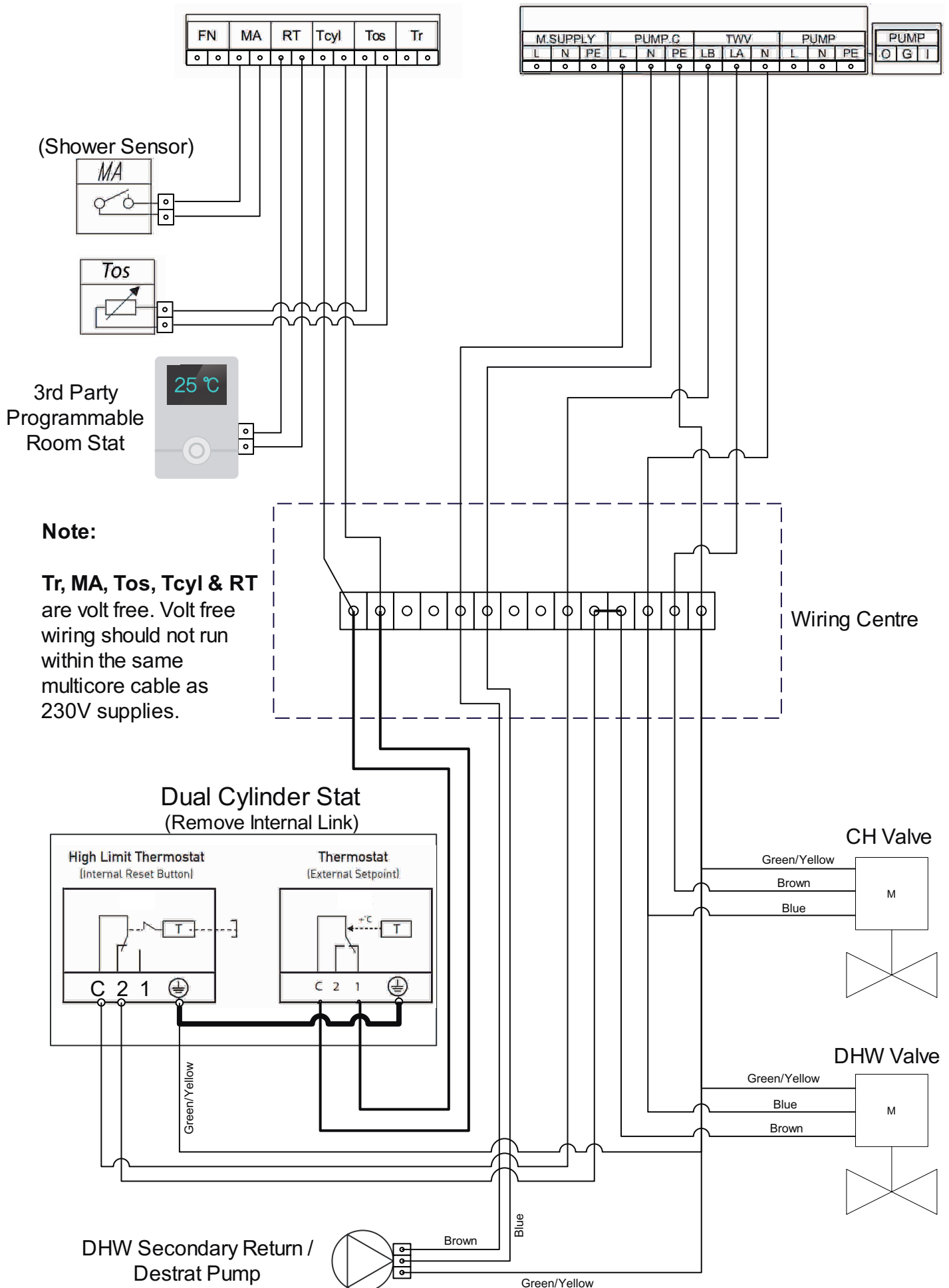



# Standard Boiler Control Wiring (S-Plan)

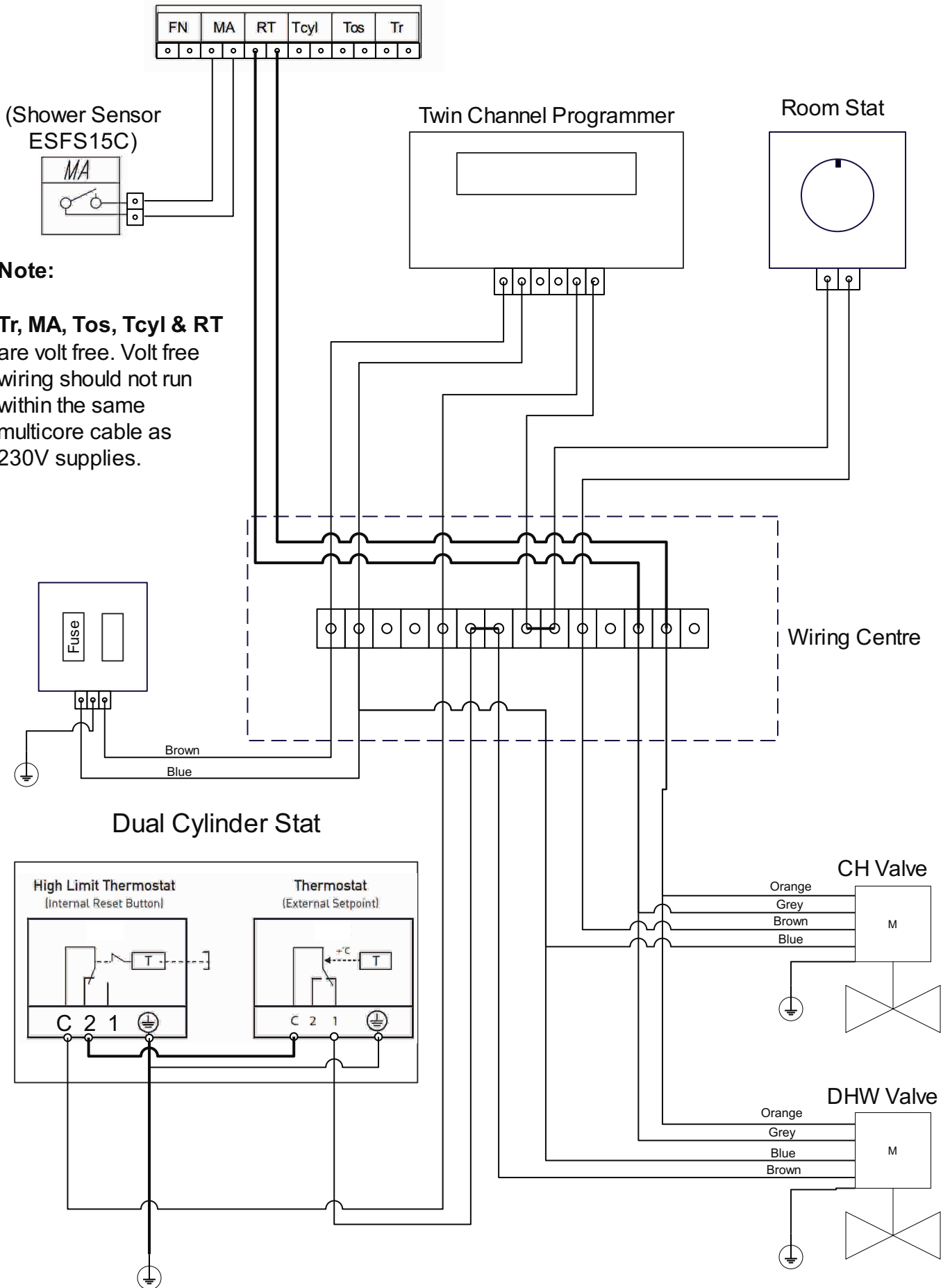

## Necessary steps involving initial commissioning

---

1. Commissioning of the Boiler heating system and checking its correct operation (correct setting of operating parameters and their adjustment to the thermal properties of the building and the installation).
2. Configuration and setting of basic operating parameters (programming of the room temperature and DHW water).
3. Evaluation of the installation for leaks, disturbing noises.
4. System balancing with the inclusion of flow rates and Pump Head setting.
4. Initial instruction of the user on the use of the Boiler & Heating System.
6. Registration of commissioning and warranty should be completed electronically by the installation company during installation by scanning the QR/NFC Tag located on the front of the boiler.

Activities to be carried out during pre-commissioning:



**SCAN ME I'M HERE TO HELP!**

Commissioning  
Warranty Registration  
Service  
Repair

We're here to help,  
tap your phone or scan  
here for more information

**ehc**  
the electric heating company

For Additional Support Call 01698 820533  
www.electric-heatingcompany.co.uk





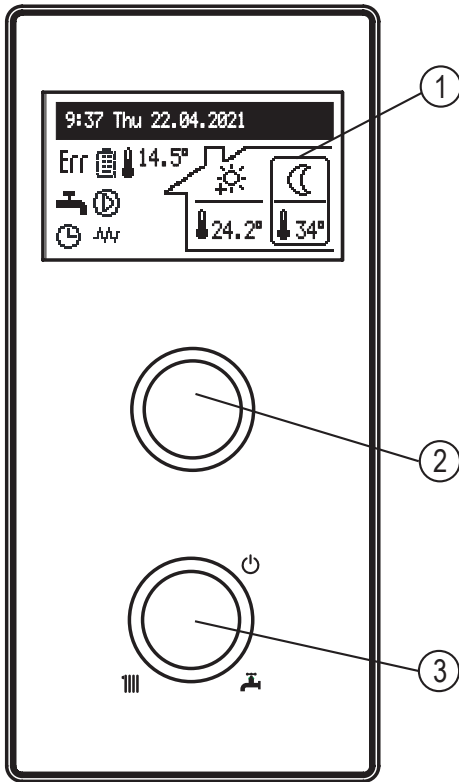

**Scan the Tag on your Heat Pump via NFC or QR to access the following features and submit the required Commissioning & Warranty information.**

- > **Boiler Commissioning**
- > **Warranty Registration**
- > **Service Log**
- > **Installation Manuals**
- > **Repair Videos**
- > **Spare Parts**
- > **Warranty Terms & Conditions**
- > **Extended Warranty**

## Control panel



- [1] - display  
 [2] - navigation dial  
 [3] - operating dial

Around the mode selection dial [3], there are symbols for CH , DHW  and the standby mode . By turning the dial to the left or right, you can successively set the operating modes: standby , or CH , or DHW  or CH+ DHW .

By turning the navigation dial [2] (to the left or right) in all modes except for the standby mode, different functional screens are displayed on the screen [1]. It is also possible to display screens for C.MG3 circuits if they are connected to the boiler.

- main: provides information about the basic parameters of the boiler (details in the table),
- parameter overview: information on the status and values of the boiler parameters,
- statistics: information on energy consumption,
- settings: adjusting the parameters of the boiler and C.MG3 modules to the user's preferences,
- boiler and C.MG3 modules parameter configuration: adapting parameters to the conditions of the facility,
- service: (available for specialized service providers after entering an access code),
- quick modes: switching the boiler to special modes.

Entering the various functions is done by selecting the appropriate functional screen and pressing the navigation dial.

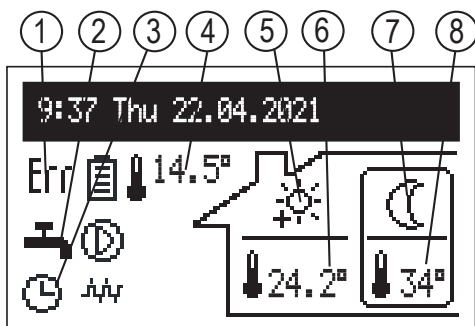

Boiler's error is signalled by **Err** icon on the main function screen. After pressing the navigation dial [2], the list of detected errors is displayed.

### MAIN SCREEN:











- [1] - Error occurrence signaling in the device  
 [2] - Heat reception type signaling  
 [3] - Heating program execution signaling  
 [4] - Outdoor temperature  
 [5] - Operation with the central heating schedule. The symbol indicates the currently realized room temperature  
 [6] - Room temperature  
 [7] - Operation with the domestic hot water schedule. The symbol indicates the currently realized storage tank temperature.  
 [8] - Storage tank temperature







### Heat reception

	Hot water heating / DHW cylinder
	CH system heating
	Buffer charging





### Heating program execution

	Forced extraction from C.MG3 heating modules
	According to the daily/weekly schedule
	PARTY – maintaining a comfortable temperature in the room and the DHW cylinder
	HOLIDAY - maintaining a comfortable economical or anti-freeze temperature in the room or anti-freeze protection in the DHW cylinder
	MANUAL - keeping the set room/DHW cylinder temperature, ( preset schedule inactive )
	TURBO - heating up with the maximum parameters until the set room temperature is reached
	DHW cylinder disinfection
	Circulation pump venting
MA	Heating blocked by signal from master device
FN	Shorting the FN input - execution of forcing according to the setting [Configuration>Entry FN].





### Temperature settings for the room

	Frost protection
	Economy temperature
	Comfort temperature
	Comfort temperature plus
	Comfort temperature minus
	Request for heating from room regulator ( connected to RT entry )
23.5°	Executed temperature value - working in manual CH mode

### DHW cylinder temperature settings

	Frost protection
	Economy temperature
	Comfort temperature
	Request for heating from outside regulator ( connected to Tcyl entry )
47°	The numerical value in the field of the realized temperature - operation in manual DHW mode and with the temperature increase from the PV signal [Configuration>Entry FN: PV]

### Signaling other settings

Err	Device's error indication
	Circulation pump operation indication (pulsating means that minimum flow is not provided) For boilers with rated power up to 8kW, the minimum flow rate is 3.5 l/min, for higher powers 4,5 l/min.
	Heating on indication
	The PV energy limit is on. If all the power is used, the displayed battery symbol is empty.
	Symbol placed next to room temperature value - room temperature control enabled. Symbol placed next to the outside temperature value - temperature control according to the heating curve.
	Symbol placed next to room temperature value - room temperature control disabled. Symbol placed next to the outside temperature value - constant heating parameters, independent of external temperature

## STATISTICS:



Current and historical energy consumption data.

- Daily counters: energy consumed on individual days of the month.
- Monthly counters: energy consumed in each month.
- Remaining energy (visible when the energy consumption limit is set up [*Configuration>PV options>Energy limit: Yes*]): amount of energy to consume.
- Consumed energy: total energy consumed by the device.
- Energ. cur. week: energy consumed in the current week.
- Energ. prev. week: energy consumed in the previous week.
- Energ. cur. year: energy consumed in the current year.
- Energ. prev. year: energy consumed in the previous year.

For cascade operation, the value of energy consumed is the sum of the energy consumed by all boilers in the cascade.

## SETTINGS:



Adjusting boiler parameters to user preferences.

- **Boiler temperature:** Target CH temperature (only available in basic mode and setting the constant parameters of CH [*Configuration>Central heating>Regulation: Constant*]).
- **Room temp.:** setting the requested room temperature, available with activated Tr sensor [*Configuration>Room temp.>Temp. sensor: Tr*].
  - Economy temp. ☾, Comfort minus ☹, Comfort ☼, Comfort plus ☺: setting room temperature values available in schedules,
  - PARTY, HOLIDAY: select temperature parameters for programs: PARTY & HOLIDAY.
- **DHW temperature:** setting requested temperature of the DHW cylinder, (available only with activated inside regulation. [*Configuration>DHW cylinder>Regulation: Inside*]):
  - Economy temp. ☾, Comfort ☼: setting hot water temperature values available in schedules
- **Energy [kWh]:** Energy availability counter. In the event that it is necessary to limit energy consumption, the amount of available energy should be entered (e.g., surplus from PV installation production). Once the declared amount of energy is exhausted, the boiler will not activate heating, even if it is forced by the PV signal at the FN input. This function is available when the energy limit is turned on [*Configuration>PV options>Energy limit: Yes*].

### Tip

That the function "Energy" is not available in cascading mode.

### Tip

The rated parameters of the device are used to calculate the energy consumption, in case of deviations, there will be slight discrepancy from the indications of the measuring devices of the grid operator.

- **CH program** (only available in basic mode with activated sensor Tr [Configuration> Room temp.>Temp. sensor: Tr]):

CH program	No1
1 6:00 - 9:15	☀️
2 15:20 - 22:15	☀️

- [1] - no. of time frame according to schedule (max 5)
- [2] - start time of the selected temperature
- [3] - finish time of the selected temperature
- [4] - temperature selection: ☀️, ☀️, ☀️, ☀️

- No. 1...No. 8: setting 8 daily programs. In each daily program there are 5 editable time frames, which can have one of the room temperature sets (☀️, ☀️, ☀️, ☀️). In any other case, the economy temperature will be activated (🌙).
- Setting up daily programs procedure is described in **Daily Schedule paragraph**.
- Weekly: assigning for each day of the week one of the previously set daily programs.

- **Buffer load program** (only available in buffer mode [Configuration>Working mode: Buffer]).

Buffer load program	No1
1 6:00 - 8:00	
2 18:30 - 23:00	

- [1] - the number of the time interval (max.5)
- [2] - buffer charging start time
- [3] - buffer charging finish time

- No.1...No.8: setting of 8 daily programs, in each daily program there are available 5 time frames in which the buffer will be charged.
- Setting up daily programs procedure is described in **Daily Schedule paragraph**.
- Weekly: assigning for each day of the week one of the previously set daily programs.

- **DHW program** (only available in DHW cylinder systems with internal adjustment activated [Configuration>DHW cylinder>Regulation: Inside]).

DHW program	No1
1 6:20 - 8:00	☀️
2 18:30 - 23:00	☀️

- [1] - the number of the time frame (max.5)
- [2] - start time of the selected temperature
- [3] - finish time of the selected temperature
- [4] - temperature selection: ☀️, ☀️

- No. 1...No. 8: setting 8 daily programs. In each daily program there are 5 editable time frames, which can have one of the cylinder temperature sets (☀️, ☀️). In any other case, the economy temperature will be activated (🌙).
- Setting up daily programs procedure is described in **Daily Schedule paragraph**.
- Weekly: assigning for each day of the week one of the previously set daily programs.

- **Circulation program:** DHW circulation pump schedule, available only within active circulation in DHW system [Configuration>Circulation: Yes].

Circulation Program	No1
1	6:00 - 8:00
2	18:30 - 23:00

[1] - no. of time frame according to schedule (max 5)

[2] - start time of circulation pump operation

[3] - finish time of circulation pump operation

- No. 1 ... No. 8: setting of 8 daily programs in each daily program. There are 5 adjustable time frames in which the circulation pump will work.  
Setting up daily programs procedure is described in **Daily Schedule paragraph**.
- Weekly: assigning for each day of the week one of the previously set daily programs.

- **Disinfection** (only available in systems with DHW cylinder):

- Temperature: the value of the temperature in the tank during disinfection,
- Week day: the day for disinfection during automatic program,
- Hour: the time of disinfection in automatic program,
- Working time: time of disinfection (calculated from the moment the temperature has reached disinfection value),
- Automatic mode: automatic start of disinfection at the set time (time, day of the week),
- Circulation: disinfection of the entire DHW installation or only the DHW cylinder (available only with active circulation),
- Activate now:
  - On - manual start of disinfection (regardless of the set day of the week and time)
  - Off - manual interruption of the disinfection process (whether started manually or automatically)

- **Time/Date:**

- - setting of the current system time (YEAR / MONTH/ DAY / HOUR).

#### Tip

The memory is saved when the „Save and end“ option is selected. In the case of a connection with C.MI2, the time is corrected by the internet module.

- **Interface:**

- Brightness min: setting the brightness of the display in stand-by mode.
- Brightness max: setting the brightness of the display during the work.
- Sound:
  - Yes - activation
  - No - deactivation of the sound signaling of the knob operation.
- Dial sensitivity: 1 - high / 4 - low.

- **Language:** menu language setting

- **System:**

- Type: EKCO.Mx3 (ID)
- MSK program: boiler's driver version
- PW program: the version of panel's program
- Max rated power: boiler's set rated power
- Pump type: type of pump installed in the CH system
- Reset: boiler's start-up
- Factory settings: restore to factory settings

## CONFIGURATION:

**Configuration:** adaptation of the boiler to the heating system in the facility.



\* Changes in the configuration menu are possible after entering an access code. When prompted for an access code, turn the navigation dial to the required code and confirm the code by pressing the dial. If you want to retract from the code request screen, hold the navigation dial or wait until automatic return to main function screen.

**Code : 987**

- **Buffer** (available only in buffer mode [Configuration > Working mode: Buffer]):
  - HW coil temperature: temperature of the buffer charging medium.
  - Load off-program:
    - Yes - consent to work outside the schedule with parameters according to the needs of the heating modules
    - No - charging in time frames according to program
- **Central heating:**
  - Weather comp.\*\*: Choice of heating curve.
  - Offset\*\*: offset of the heating curve.
  - Max. boiler temp.\*: maximum CH temperature.

**Attention: adjustment of too high temperature parameters not compatible with the type of building, central heating installation and building's insulation may lead to high exploitation costs.**

- Set boiler temp.\*\*: Temperature in CH installation when cooperating with constant parameters and in emergency conditions.
- Regulation\*\*: type of temperature regulation (parameter only available in standard mode).
  - > Per curve: temperature in CH installation is calculated on the basis of outside temperature and heating curve parameter.
  - > Constant: temperature in CH installation is equal to „Set boiler temp.“

\*\* not available in buffer mode and source mode

\* not available in buffer mode.

- Frost protection: frost protection of the building.
- Boiler protection:
  - Yes - if the temp of the inside sensor of the boiler drops below 5°C, the circulation pump will turn on
  - No - protection turned off
- **Outside temp:** the configuration parameters of the outside temperature sensor.
  - Tos sensor:
    - Yes - sensor on, all functions related to external temperature will be active,
    - No - sensor inactive - disables the „Outside temp. off“ and „Tos calibration“ functions. In the absence or failure of the sensor, the error Tos is not displayed.
  - Outside temp off: the value of the outside temperature after which the heating of the CH circuit is switched off. The hysteresis equals 2°C. For example, for a setting of 15°C, the heating will be switched off if the outside temperature reaches 15°C, the heating will be switched on if the outside temperature drops to 13°C. Parameter available with active Tos sensor.
  - Emergency out. temp.: the parameter used to calculate the heating curve in the event of a failure of the outside temperature sensor
  - Tos calibration: calibrating the value of the indicated outside temperature. Depending on the character, the parameter is added or subtracted from the measured value. Parameter available with active Tos sensor.



- **DHW cylinder:**
  - Control: selection of the three-way valve control pattern:
    - A-CH B-DHW
    - A-DHW B-CH
  - DHW coil temperature: coil's feed temperature
  - Regulation: DHW cylinder temperature control:
    - Inside: performance according to the internal controller (built into the device), the time programmer and the measured temperature in the cylinder. To work in internal controller mode, Tcyl sensor is required.
    - Outside: according to external thermostat ( in „Outside” setting the following modes are not available: „DHW temperature”, „DHW program”, „Disinfection” and „DHW manual” mode.
  - Turn on/Cancel: turning on/off the DHW function.
  
- **Circulation:** enabling or disabling the DHW circulation pump control and DHW system circulation function.
  
- **Room temp.:**
  - Temp. sensor: choosing the type of room thermostat
    - RT - external room controller (heating order by short-circuiting the contact at RT entry),
    - Tr - internal room controller, room temperature sensor connected to the Tr input.
  - Tr control: room temperature control
    - Yes - heating turned off after reaching set room temperature.
    - No - room temperature control disabled. The readout of the room temperature does not affect the central heating operation (except for heating for frost protection purposes).
  - Parameter active and visible only at the [Temp. sensor: Tr] setting.
  - Tr hysteresis: room temperature hysteresis with Tr control enabled [Configuration > Room temp. > Tr control: Yes].
  - Tr calibration: calibration of the indicated room temperature. Depending on the character, the parameter is added or subtracted from the measured value.
  
- **Aut. Turbo mode:**
  - Turning on the boiler in the event of a large difference between the set and the current room temperature (Tr). The boiler activates with the maximum temperature setting until the set temperature is reached, and then it switches to the programmed operating mode.
  - Tr hysteresis: a drop in room temperature which triggers the turbo function.
  - DHW cylinder:
    - No - DHW priority in Turbo mode turned off
    - Yes - DHW priority in Turbo mode turned on
  - Cancel: - turns off automatic Turbo mode.
  - If Turbo mode is off - menu will only show a possibility to turn it on.
  
- **Pump:**
  - Pump over run: Hour of brief pump activation after a 24-hour standstill (protection against blockage).
  - Automatic mode:
    - Yes - the pump operates according to demand,
    - No - the pump operates continuously.
  - Regulation:
    - Const p.: constant pressure
    - Variable p.: variable pressure
  - In the regulation mode („Const p.”), the pressure difference produced by the pump is maintained at a constant set level in terms of performance to pump's maximum characteristics. This type of regulation is recommended for floor heating or older heating systems with pipes of larger diameters, as well as for all applications with constant characteristics.
  - In the regulation mode („Variable p.”) the pressure difference produced by the pump is maintained at the level of settings changing linearly between 1/2H and H. Setting pressure differences decreases or increases depending on the flow. This regulation type is recommended for heating systems with heaters, thanks to which flow noise in thermostatic valves is reduced.
  - CH venting:
    - Turn on: start the process of venting the installation in the CH circuit,
    - Turn off: venting process termination.
  - DHW venting:
    - Turn on: start the venting process of the installation in the DHW circuit,
    - Turn off: venting process termination.

During the venting procedure (10 min), the pump operates alternately at maximum and minimum rotational speed. Thanks to this, air bubbles are amassed, which facilitates their removal from the system. Once the process is complete, it will automatically shut down. During venting, the heating process is blocked.

- H max: the height of the pump lift. Adjust the parameter value according to the CH installation and boiler's power. The parameter directly affects the value of the factor flow through the installation. Too high or too low flow rate directly affects the economy of the CH installation and the power consumption.
- **Boiler rated power:** setting rated power for particular work types:
  - Max rated power: setting maximum power rate
  - CH limit: maximum heating power set for CH
  - DHW limit: maximum heating power set for DHW, available only with DHW cylinder function turned on [*Configuration>DHW cylinder>Turn on*].
  - PV limit: maximum heating power when increasing the circuit temperature through PV mode. Option available when the FN output is set to PV [*Configuration>Entry FN: PV*].
- **Entry FN:** selection of boiler mode for short-circuit entry FN.
  - Off: entry FN inactive.
  - ☺: forcing the economic temperature in CH and DHW circuits,
  - ❄: forcing the anti-frost temperature in CH and DHW circuits,
  - PV: Forced PV mode, involving heating outside the schedule with user-limited power to raise the temperature parameters of the circuit. Option not available for cascade operation.

*Tip*

When installing with a storage tank, forcing PV mode causes the DHW temperature to rise to 60°C.

- **Communication:**
  - Device number: device's number in the bus.
- **Pressure sensor:**
  - No - turning the control off
  - Yes - turning the control onPressure control should be switched off only when boiler works in an open CH system.
- **Working mode:**
  - Standard: boiler is the only device that controls CH system.
  - Source: the boiler acts only as a heat source and the heating system is controlled by heating modules (see the C.MG3 heating module user manual).
  - Buffer: the boiler controls the function of charging the buffer, buffer discharge is controlled by the heating modules (see the C.MG3 heating module user manual).
- **PV options:**
  - Energy limit:
    - Yes - activation of the energy consumption limit function - the boiler will be turned off after exhausting the electric energy limit set by the user [*Settings > Energy*].
    - No - energy limit turned off
  - Tr offset: The value by which the boiler can increase the room temperature at the moment of PV energy production (closed FN contact). This function is available in:
    - basic operating mode [*Configuration > Working mode: Standard*]
    - FN entry set to PV [*Configuration > Entry FN: PV*].
- **Cascade:**
  - No - disabled operation in the cascading mode,
  - Yes - enabled operation in the cascading mode.

*Tip:*

1. Cascade connection of boilers is not available in buffer mode.
2. With an active cascade, all functions related to PV are not available.

Exit any menu item by pressing „End” or by pressing and holding the navigation dial. When not operated by the user, main function screen will appear after about 3 min.

If C.MG3 heating modules are connected to the boiler, additional options will be displayed in the configuration menu. A detailed description can be found in the module manual.

## SERVICE:

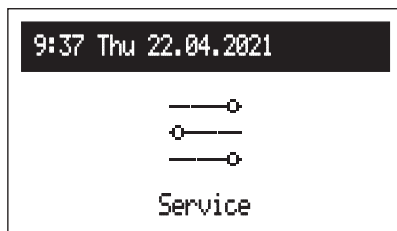

Diagnostic tools, access for the installation company and specialized services after entering the access code.

## FAST MODES:



Fast switching algorithm of work depending on the needs.

- Party: setting the mode's duration (from 1 to 24 hours or until cancellation). During party mode, the boiler will provide heat to the CH installation accordingly to the user's defined room temperature setting [Settings > Room temp. > Party], and the DHW installation with comfort temperature.
- Holiday: mode duration (from 1 to 60 days or until cancellation). During the holiday mode, the boiler will provide heat to the CH installations accordingly to the user's defined room temperature setting [Settings > Room temp. > Holiday], and the DHW installation with anti-frost temperature.
- CH manual: setting the room temperature to be executed by the control system. In manual mode, the timer's work is suspended until cancellation.
- DHW manual: setting the DHW cylinder's temperature to be executed by the control system. In manual mode, the timer's work is suspended until cancellation. Mode available only with active DHW cylinder.
- Turbo: heating the object with the maximum temperature setting until the desired room temperature is reached. Turbo mode is available if the temperature in the room drops below the currently maintained temperature.

If a specific mode is enabled, an icon  is displayed. Once enabled, enter the mode in order to turn it off. In manual CH or DHW modes, the set temperature can be changed.

Manual CH and manual DHW modes can be set simultaneously. Any other combination of two or more modes is not possible, setting the second mode disables the mode currently running. The exception is the turbo mode, which doesn't work with holiday mode.

### Tip

*The increase caused by the PV mode also applies to fast modes, except for Vacation.*

## Start-up

Upon the initial startup of the boiler, or after restoring factory settings, it is necessary to select the menu language, and then determine the maximum power of the boiler from the list. Consideration should be given to the building's thermal power demand, the allocated electric power supply from the power company, and the capabilities of the existing electrical installation.

Subsequently, the boiler's operation should be configured and adjusted to the building's parameters according to the points described in the Configuration and Settings chapters. Only after setting this data can the boiler operate correctly.

## Daily program:

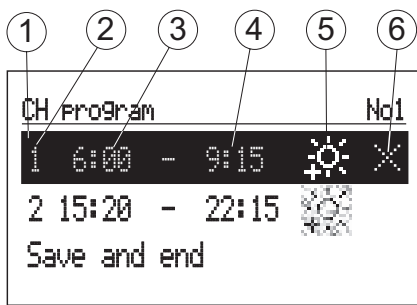

- [1] - time period panel
- [2] - no. of time frame according to schedule (max 5)
- [3] - start time
- [4] - finish time
- [5] - temperature selection (CH and DHW cylinder)
- [6] - command (active when editing):
  - accept
  - delete
  - add

In daily schedule CH circuit and DHW cylinder have defined starting time (3) and finishing time (4) of maintaining selected temperature value (5) in the room (CH) or DHW cylinder. Outside defined time frames economy temperature will be maintained in the room/cylinder. For circulation circuit within the schedule there is an adjustment of start time (3) and finish time (4) of circulation pump's operation. In buffer mode there is an adjustment of start time (3) and finish time (4) of buffer's charging. To change the parameters for the daily schedule select chosen program number and press navigation dial.

The first parameter flashes (start time) - use the navigation dial to set the new time frame value (hour and minutes separately) by turning the dial left/right and confirm it by pressing the dial again. At the same time next screen starts to flash allowing edition of next parameters (finish time). Last editable position is a command. In order to save changes select command save  and press the dial to finish editing. To delete selected time frame start editing chosen time frame and by pressing the dial go to command position, select command delete  and press the dial. To add new time frame, select last defined time frame and by pressing the dial go to command position, select command add  and press the dial to add new time frame (edition of new time frames described above).

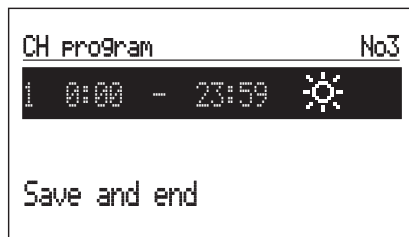

If there are no defined time frames, then after selecting „new” the time frame 00:00am to 23:59pm will be set, which should be edited in accordance with user's needs.

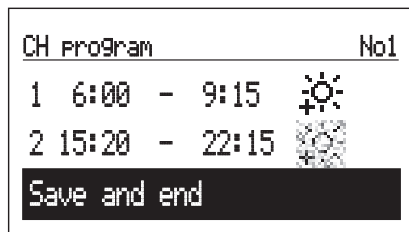

The daily program will be saved to the boiler's settings by pressing the command „Save and end”.

## Turbo mode

If an object is cooled down and there is a need for its rapid heating, the TURBO function can be activated. This function, when the conditions for enabling heating are met, initiates the heating of the central heating circuit with the maximum temperature setting until the required room temperature is reached. This function can start automatically when room's temperature falls down by the set value of Tr hysteresis. Automatic work is set in menu [Configuration > Aut. Turbo mode] Selection of „DHW cylinder: No” will result in switching off hot water heating priority for the time of using „Turbo” function. In fast modes menu it is possible to turn on this function manually (without hot water heating up priority), in condition that the room's temperature is lower than the programmed one. Tr sensor is required to turn on the Turbo function.

## Building anti-frost protection

Function's activation [Configuration > Central heating > Frost protection: Yes].

The frost protection function does not allow the building to cool down drastically. The protection program starts the CH process if the following conditions are met:

- the outside temperature drops below 2°C. In case of failure of the Tos sensor, this condition will always be met,
  - the room temperature drops below 5°C. In case of failure of the Tr sensor, the frost protection program will not turn heating on.
- Depending on the type of regulation, the temperature setting of the heating medium will be set accordingly to the calculations for the heating curve or manual setting. If the outside temperature rises to at least 3°C or the room temperature rises to at least 6°C, the CH will be switched off. The building protection function is inactive when controlling the boiler with an external room controller connected to the RT entry.

### Tip

In the Source and Buffer operating modes, the boiler can activate heating to protect the building regardless of the C.MG3 setting, and the heating medium temperature is fixed at 25°C.

## Heating curve

Boiler's controller is responsible for maintaining proper temperature in central heating installation depending on the outside temperature. While the temperature outside the facility is low, heat demand within the facility is higher, whereas while the temperature outside is high, analogically, there's no need to maintain high temperature within the installation. Correlation between outside temperature and heating installation's temperature can be presented in a graphical form of so called heating curve. The diagram below presents a compilation of heating curves for the set point of room temperature equal 22°C. Depending on the facility characteristics, climate zone, and the type of heating installation one must select appropriate heating curve [Configuration > Central Heating > Weather comp.].

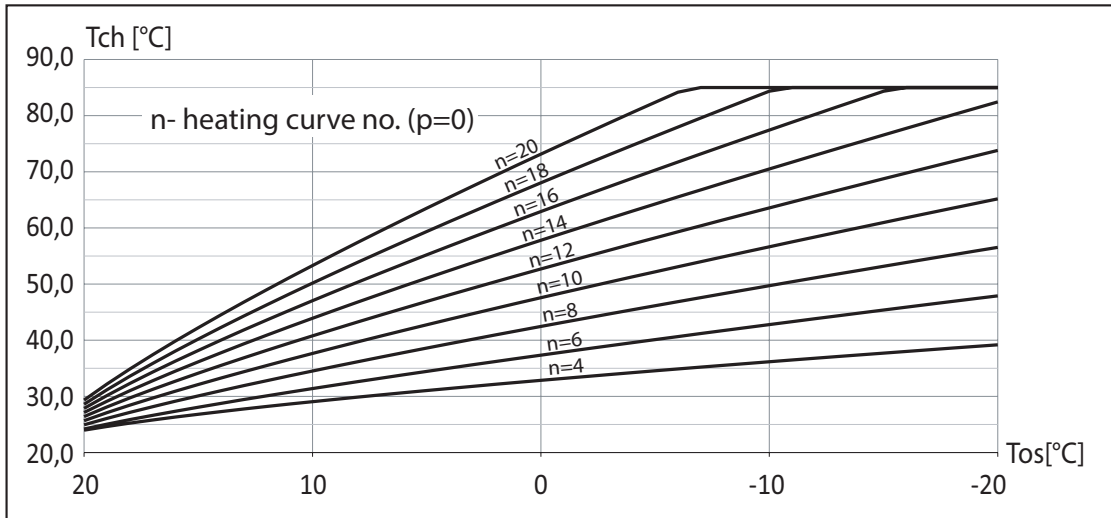

In case of the need to offset the heating curve, it is necessary to change the parameter [Configuration > Central heating > Offset]. The diagram below presents heating curve no. 12 with the offset -10°C and 10°C.

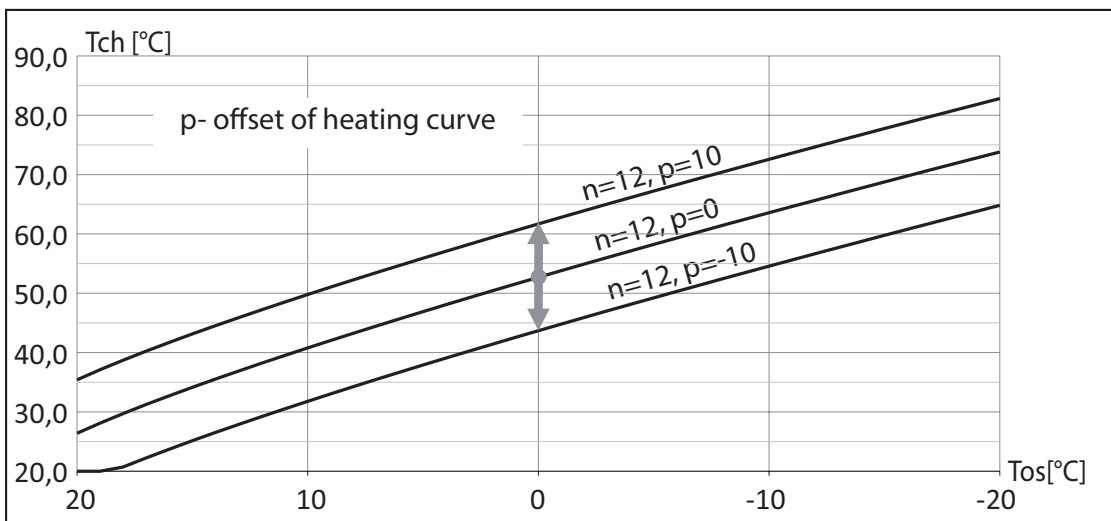

### Tips on setting the "heating curve"

Course of heating	Actions concerning the "heating curve"
During cold seasons, it is too cold indoors.	Set the „Weather comp.“ to the next higher value.
During cold seasons, the rooms are too warm.	Set the „Weather comp.“ to the next lower value.
During transitional and cold seasons, it is too cold indoors.	Set the „Offset“ to a higher value.
During transitional and cold seasons, the rooms are too warm.	Set the „Offset“ to a lower value.
It is too cool indoors in transitional seasons, yet it is warm enough in cold seasons.	Set the „Weather comp.“ to the next lower value and the „Offset“ to a higher value.
It is too warm indoors in transitional seasons, yet warm enough in cold seasons.	Set the „Weather comp.“ to the next higher value and the „Offset“ to a lower value.

## Cooperation with PV installation

Photovoltaic systems are usually equipped with software controlling the external load in order to increase the degree of energy self-consumption within the internal (home) network. High self-consumption means consuming as much energy as possible produced by PV system. Depending on the performance of the inverter, the external power control can be carried out on the basis of the power generated or the excess power generated. Control on the basis of excess power generated is the optimal solution, as the energy that would be returned to the operator's grid will be consumed within the internal network. However, this requires a complex inverter measuring system. In case of power-based control, the level of energy consumption within the internal grid is unknown, therefore energy from the operator's grid may be selected.

Inverter's cooperation with the boiler means modifying the operating algorithm of the device in order to convert the excess energy produced into a controlled increase in the temperature in the building or an increase in the temperature of domestic hot water in the DHW cylinder.

How to connect the inverter to the boiler is shown in the diagram below:

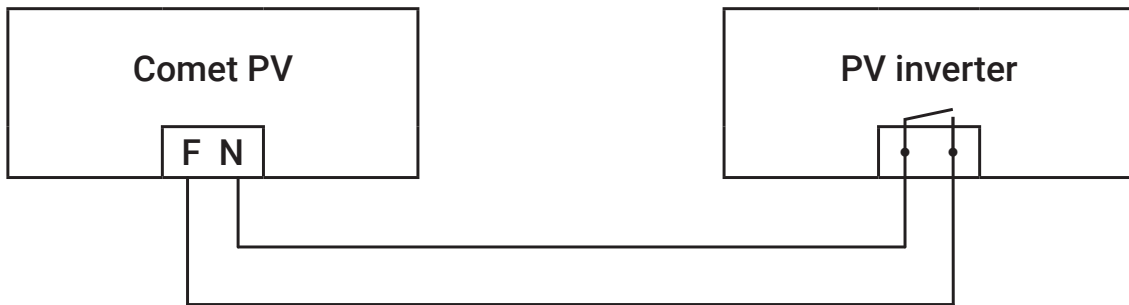

The relay output of the PV inverter for external load management must be connected to the boiler's FN entry. If the inverter has a voltage output, use an appropriate intermediate relay. In order to activate the boiler's PV functions, it is necessary to:

1. Set the FN entry to PV mode: *[Configuration > Entry FN: PV]*.
2. Turn off cascade mode: *[Configuration > Cascade: No]*.
3. Set the power limit for PV function: *[Configuration > Boiler rated power > PV limit]*.
4. For the basic mode of operation, it is necessary to set the room sensor to Tr *[Configuration > Room temp. > Temp. sensor: Tr]*. The set value indicates the maximum boiler power to be switched on in PV mode.

In the inverter, set the power at which the relay will be shorted and the power at which the relay will be open. Depending on the degree of sophistication of the management function, other parameters may be available, i.e. minimum relay switching time. A prerequisite for switching the boiler to PV mode is the short circuit of the FN entry by the inverter (after meeting the power production criteria). In this case, limited power heating (PV power limit) occurs if:

- the temperature of DHW will reach the set point resulting from the schedule or manual setting,
- the room temperature reaches the set value resulting from the schedule or manual setting.

If the DHW cylinder is being heated in PV mode, the process will be completed when it reaches 60°C. For CH, when the temperature resulting from the schedule or manual setting is reached, the heating will continue to the temperature resulting from the Tr offset *[Configuration > PV options > Tr offset]*. For example, for a comfort temperature set at 22°C and Tr offset of 1°C, after reaching the setting, the heating will continue with the power limit *[Configuration > Boiler rated power > PV limit]*. At 23°C, the heating will be switched off or continued in normal mode with room temperature control off. In buffer mode, the buffer tank will be charged off schedule with PV power set, in case of heating request by schedule or heating circuits, the boiler will start heating with full available power. In buffer mode, the buffer tank will be charged outside the schedule with the PV power set *[Configuration > Boiler rated power > PV limit]* until the supply temperature is reached *[Configuration > Buffer > HW coil temperature]*, and in the case of heating through the schedule or heating circuits, the boiler will heat with the power set for central heating *[Configuration > Boiler rated power > CH limit]*.

## Cascade mode

In order to increase the power of the heating system, boilers can be combined into a cascade.

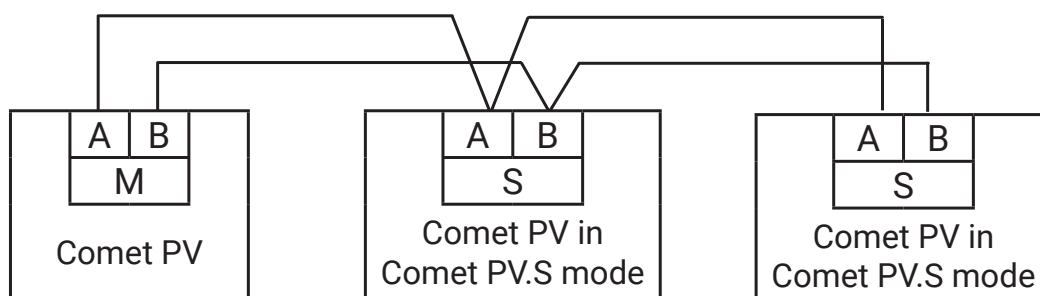

Comet PV master boiler controls Comet PV boilers set in slave operating mode (see position of switches in cascading mode

- chapter Installation). In order to activate the cascade mode, it is necessary to:
- set the configuration switches of master boiler to the Comet PV position,
- set configuration switches of slave boiler to the Comet PV Slave position,
- set individual identification numbers for each device [*Configuration > Communication > Device number*]. If the same numbers are given, there will be irregularities in communication, which will prevent proper operation,
- activate the cascade mode in the master boiler [*Configuration > Cascade: Yes*],
- connect the communication bus according to the above drawing.

### Tip

That cascade mode is not available in buffer working mode.

## SLAVE BOILER'S MAIN SCREEN:

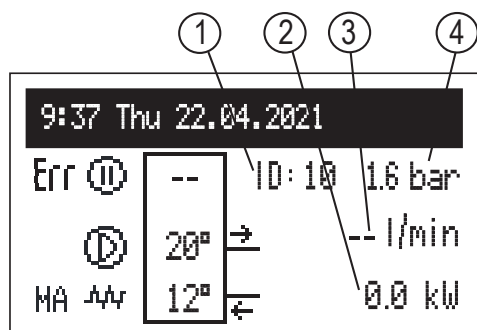

- [1] - boiler's ID
- [2] - rated power
- [3] - flow l/min
- [4] - pressure in the system

### Settings signalization:

Err	Device's error indication
MA	Heating blocked by signal from master device
ⓧ	Slave boiler performance paused
Ⓢ	Circulation pump operation indication (pulsating means that minimum flow is not provided)
🔥	Heating on indication

## SETTINGS:

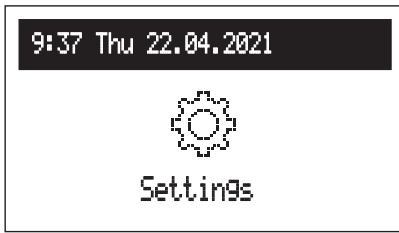

Adjusting boiler parameters to user preferences.

- **Interface:**

- Brightness min: setting the brightness of the display in stand-by mode.
- Brightness max: setting the brightness of the display during the work.
- Sound:
  - Yes - activation
  - No - deactivation of the sound signaling of the knob operation.
- Dial sensitivity: 1 - high / 4 - low.

- **System:**

- Type: EKCO.Sx3 (ID)
- MSK program: boiler's driver version
- PW program: the version of panel's program
- Max rated power: boiler's set rated power
- Pump type: type of pump installed in the CH system
- Reset: boiler's start-up
- Factory settings: restore to factory settings

## CONFIGURATION:



**Configuration:** adaptation of the boiler to the heating system in the facility.

*\*Changes in the configuration menu are possible after entering an access code. When prompted for an access code, turn the navigation dial to the required code and confirm the code by pressing the dial. If you want to retract from the code request screen, hold the navigation dial or wait until automatic return to main function screen.*

**Code: 987**

- **Communication:**

- Device number: device's number in the bus.

## SERVICE:



Diagnostic tools, access for the installation company and specialized services after entering the access code.



## Technical data

---

Max. pressure	MPa	0,3 (3 bar)
Min. pressure	MPa	0,05 (0,5 bar)
Outlet flow temperature	°C	20 ÷ 85
Max. temperature	°C	100
Dimensions (height x width x depth)	mm	716 x 316 x 235
Weight	kg	~20,5
Boiler's connections		G 3/4" (inside thread)
Expansion vessel	l	~5
Safety class		IP 22

Boiler		2 / 4 / 6 / 8			
Rated power	kW	2	4	6	8
Rated voltage		230V~			
MCB rating		16	20	32	40
Load current	A	8,7	17,4	26,1	34,8
Min. power supply cable cross-section**	mm <sup>2</sup>	2,5		4	6
Max. power supply cable cross-section	mm <sup>2</sup>	16			
Max. allowed network impedance	Ω		0,27	0,17	0,15

Boiler		12 / 16 / 20 / 24			
Rated power	kW	12	16	20	24
Rated voltage		400V 3N~			
MCB rating		20	32	32	40
Load current	A	3x17,4	3x23,1	3x28,8	3x34,6
Min. power supply cable cross-section**	mm <sup>2</sup>	5 x 2,5	5 x 4		5 x 6
Max. power supply cable cross-section	mm <sup>2</sup>	5 x 16			
Max. allowed network impedance	Ω			0,27	0,13

Boiler		7,2 / 9,6 / 12,0 / 14,4			
Rated power	kW	7,2	9,6	12,0	14,4
Rated voltage		240V 1N~			
MCB rating		40	50	63	63
Load current	A	30,0	40,0	50,0	60,0
Min. power supply cable cross-section**	mm <sup>2</sup>	4	6	10	
Max. power supply cable cross-section	mm <sup>2</sup>	16			
Max. allowed network impedance	Ω			0,24	0,22

\*\*Note; Stated cable sizes are the minimum permitted for this appliance. The required cable size for the installation should be calculated by a qualified electrician based on a cable calculation in line with BS7671 Wiring Regulations considering the cable type selected and the installation method used.

## **Product disassembly**

---

The disassembly of the central heating boiler should be carried out in the reverse order of the assembly described on page 7.

## **Packaging contents**

---

Electric boiler	1 pcs.
Hanger	1 pcs.
Mounting screws	2 sets
Gaskets	2 pcs.
Fuse	1 pcs.
WE-027 Indoor Temperature Senso	1 pcs.
WE-033/02 Outdoor Temperature Sensor	1 pcs.
WE-019/01 tap water tank temperature sensor (TCYL input)	1 pcs.
Drain funnel	1 pcs.
Warranty card	1 pcs.
User manual	1 set.

## **Optional Accessories**

---

ESFS15C Shower Flow Sensor.  
MAG-Pack Magnaclean Pro3 Smart Filter & Chemical Pack.  
AHP1004 C.MI2 Internet Module  
EC10018 - C.MG3 Heating Zone Control Module

## **Maintenance**

---

This appliance requires to be serviced by a competent engineer every 12 Months on the anniversary of the original date of installation. The Service should be recorded by scanning the smart tag located on the front of the boiler.

1. Check for leaks in the water circuit and, if necessary, replace the joints to ensure water tightness.
2. Check the status of the device visually.
3. Check the safety system of the heating system are working properly. Activate the test button on the RCD supplying the boiler.
4. Check all electrical connections of the device.
5. Clean the Magnetic Filter
6. Check the general operation of the device.
7. Check & adjust the expansion vessel pre-charge pressure to 1.5 bar
9. In accordance with Part L of the building regulations check system water condition and inhibitor strength levels. EHC recommends the use of Adey Pro Check for this task.

## Warranty Terms & Conditions

---

1. The installer must be suitably qualified to install EHC products and all Commissioning Sheets & Annual Servicing Sheets require to be made available to EHC when requested.
2. The Boiler must be installed as per the manufacturers installation instructions.
3. The Boiler Warranty starts from the date of purchase and must be registered with EHC by either the Installer or the Householder, within 60 days of the Boiler Purchase date. For new build properties, this must be done within 30 days of the sale being completed. Failure to do so will reset the Warranty Period to 2 Years for Parts and Labour only.
4. To comply with our Manufacturer's Warranty Terms the Boiler must be serviced each year as outlined in the product installation manual. The service must be carried out by a suitably qualified engineer. The service can be done up to 30 days before or after the original anniversary of the Boiler being installed without invalidating the Warranty.
5. If the service is not carried out in accordance with the guidelines within the product installation manual, the Warranty cover will become void. The guidelines are as follows:
  - a. Service intervals must be every 12 months.
  - b. Ensure that the expansion vessel pressure is set to 1.5bar
  - c. Clean external & internal magnetic filters.
  - d. Check system water condition and inhibitor strength.
  - e. Check electrical connections.
6. While the Warranty is in place, we will replace parts which were faulty from the date of purchase, at our discretion free of charge. Reasonable Labour costs will only be paid where the value has been pre-agreed and authorised by EHC prior to the repair commencing.
7. This Warranty only relates to the Boiler and integrated controls and does not include any connected system, radiators or accessories such as time switches, thermostats, motorised valves, external pumps, external expansion vessels.
8. If the Boiler breaks down, we may ask you to pay a deposit prior to the repair visit. We will return the deposit in full if we find a fault that is covered by the Warranty. We may keep the deposit if we cannot access your property at the agreed visit time or conditions mentioned in point 5 above of this Warranty have not been met. A responsible adult must be at the property to provide access to the Engineer.
9. Any repair carried out under the terms of this Warranty does not extend the Warranty beyond its original period.
10. For Boilers installed in the Channel Islands and Isle Of Mann the Standard 2 Year Parts & Labour Warranty is applicable with the option to purchase an extended warranty. For all other areas out with the UK the Warranty provided will cover parts only for a 2 Year duration.
11. Engineers will not carry out repairs if they think accessing the Boiler would be a risk to Health and Safety.
12. If your Boiler is in a cupboard, there must be sufficient room for the Engineer to work (the minimum area is set out in the installation instructions). We will not accept responsibility for removing cupboards, kitchen units, trims etc to gain access for repairs.
13. This Warranty does not in any way affect your Statutory or Legal Rights.
14. Adey Inhibitor (or equivalent) requires to be added to the system during installation and thereafter at regular intervals using the correct dosage.
15. A reputable magnetic filter requires to be installed on the return of every Boiler.
16. Existing systems require to be pressure flushed correctly and final TDS reading recorded on the commissioning paperwork.
17. This Warranty does not cover the following:
  - a. Parts which fail due to system debris, contamination and/or water quality issues,
  - b. Boilers installed within mobile leisure accommodation vehicles (LAVs) e.g. Boats, Caravans.

## Packaging disposal

---

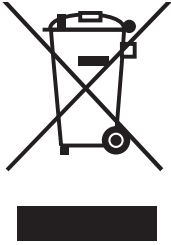

This product is labelled with waste segregation collection symbol, as established in EN 50419. This label also means that the product is marketed after 13 August 2005.

Households have an important contribution to reuse and recovery of materials, which includes recycling of waste electrical and electronic equipment (WEEE). Proper disposal of WEEE contributes to environmental protection and helps recover recyclable materials.

All packaging materials for our products are recyclable and can be converted into more products.

This product once spent shall not be disposed with mixed household waste. Return the product to a WEEE collection point for recycling. Proper disposal of the spent product prevents potential environmental impact from incorrect waste management.

For more detailed information on how to recycle this product, contact your local authorities, waste management operators or the original seller.

## Declaration of conformity; reference standards and directives

---

The Electric Heating Company Ltd declares with full responsibility that the Electric Boilers mentioned in this instruction manual are in compliance with the requirements of the current EU legislation and corresponding UK legislation for safety standards for electrical appliances for domestic use:

LVD (2014/35/EU) and Electrical Equipment (Safety) Regulations 2016 (UK)

EMC (2014/30/EU) and Electromagnetic Compatibility Regulations 2016 (UK)

and have been marked with the symbol CE and UKCA







**Electric Heating Company Ltd**

Unit 40, Block 5  
Third Road  
Blantyre Industrial Estate  
Blantyre  
Glasgow

G72 0UP

Tel: 01698 820533 Fax: 01698 825697

[www.electric-heatingcompany.co.uk](http://www.electric-heatingcompany.co.uk)