

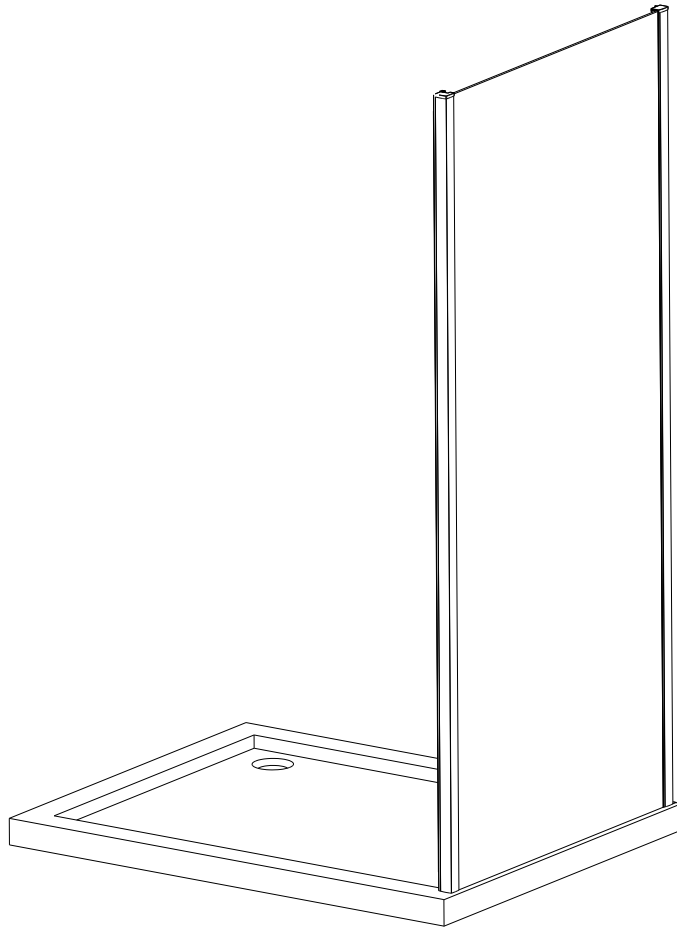





# 6mm SIDE PANEL GUIDE



## General Information

Please inspect this product upon delivery. Any missing parts or manufacturing defects must be reported immediately to the supplier. Damage or defects reported later will not be accepted. TAKE CARE WHEN HANDLING GLASS PARTS-AVOID HEAVY CONTACT BETWEEN THE GLASS EDGES AND ANY HARD SURFACE. Glass breakage claims will not be accepted after the product has been unpacked.

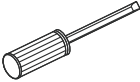
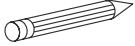
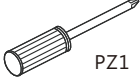
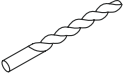
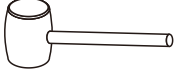
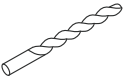
## TOOLS REQUIRED

DESCRIPTION	PART IMAGE	DESCRIPTION	PART IMAGE
Tape measure		Drill	
Spirit level		Flat-head Screwdriver	
Pencil		Cross head Screwdriver	 PZ1
Ø6mm Drill bit		Mallet	
Ø3mm Drill bit		Silicone Sealant	

 This product is heavy and may require two people to install.

## ASSEMBLY INSTRUCTIONS - DRAWING

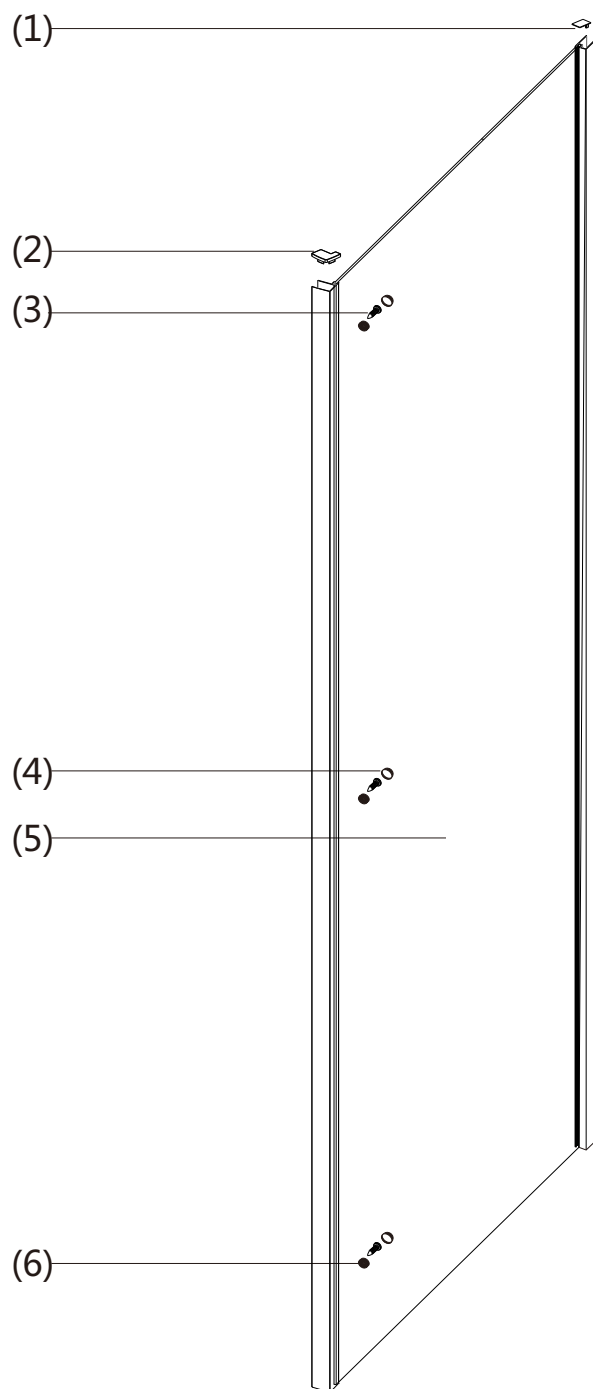

- (1) 1x Cover Cap For Upright Profile
- (2) 2x Corner Post Profile Covers L/R
- (3) 3x Screws ST4x16
- (4) 3x Screw Cover Caps
- (5) 1x Fixed Panel
- (6) 3x Screw Cover Clips

## Before Installation

Please ensure that the shower tray is level and checked with a spirit level. The tray should be installed first. Tiles should then be tiled down to the tray. The enclosure can then be installed.

### Step 1 DRILLING WALL PROFILE TO THE WALL

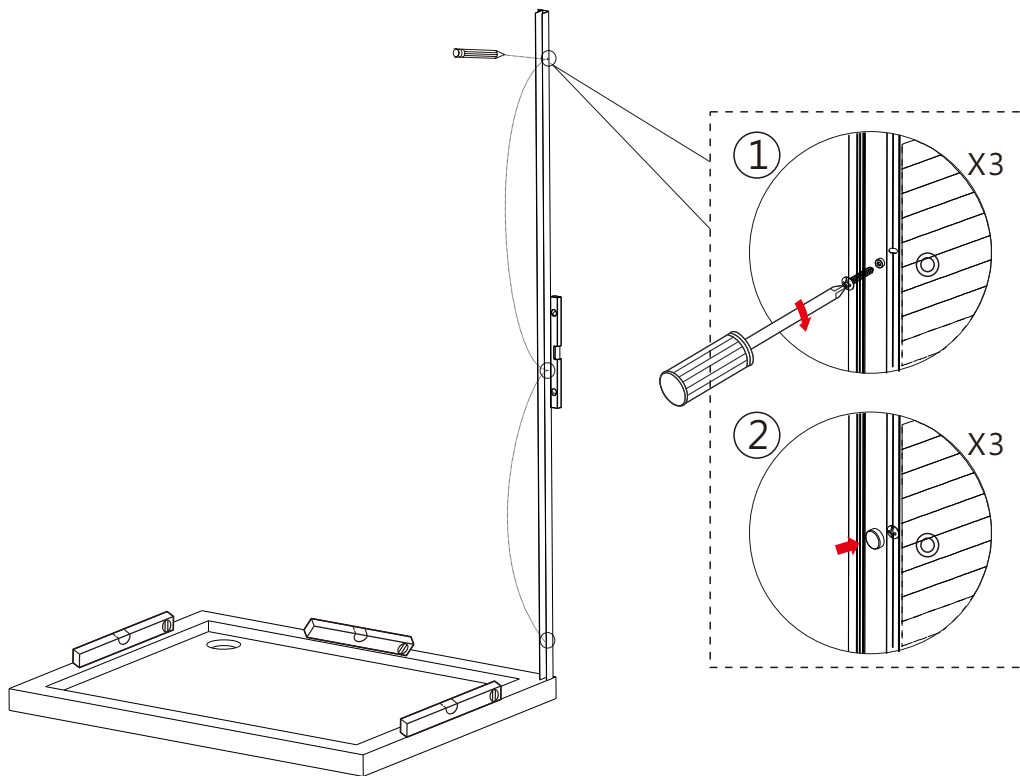

### Step 2

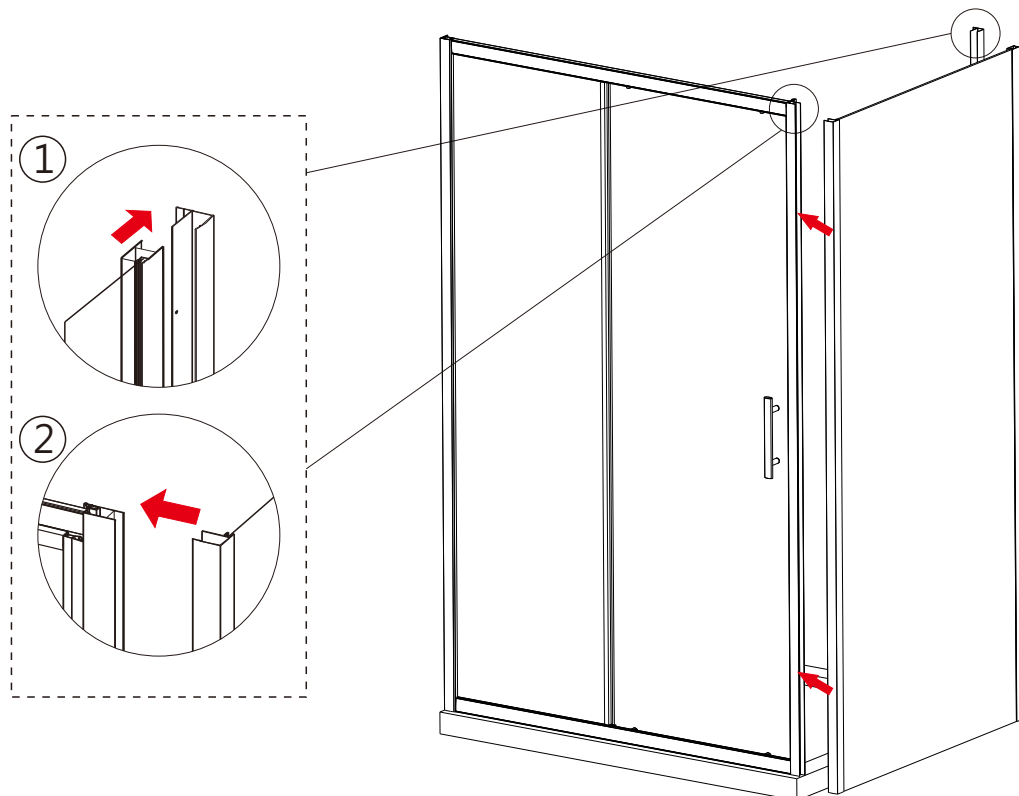

### Step 3

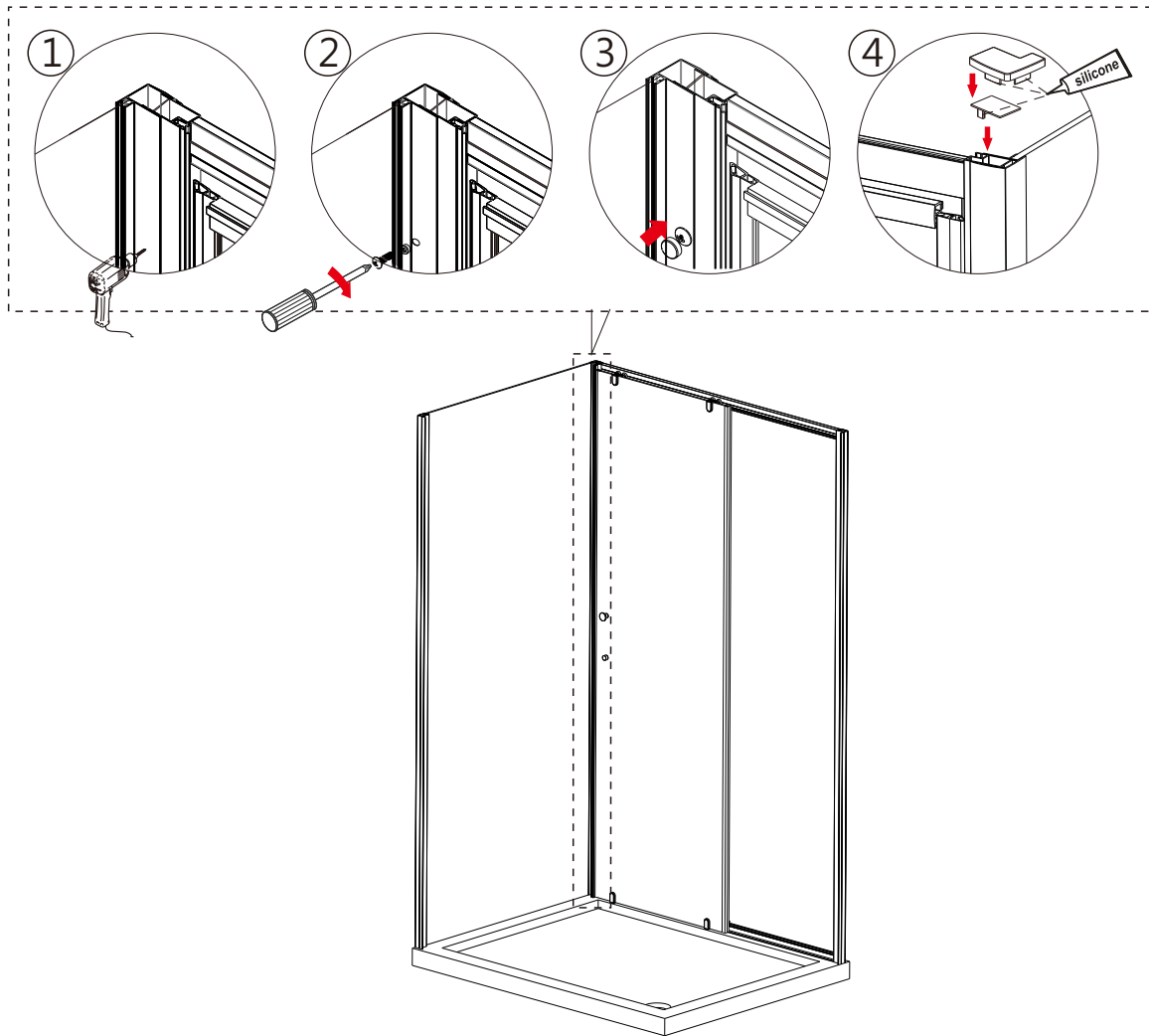

### Step 4

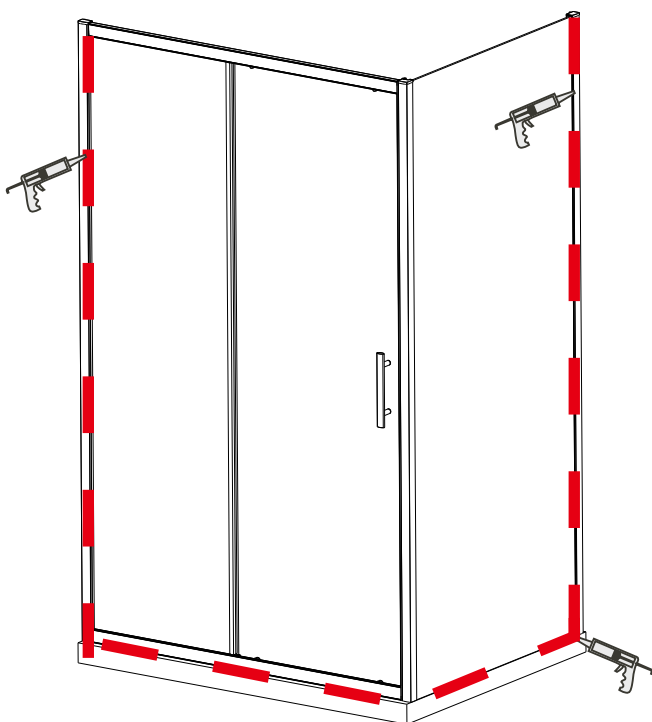

**Allow 24 hours for silicone to dry before use. Silicone on the outside edge only, NOT THE INSIDE**

### Aftercare instructions

Regularly clean your shower product with warm soapy water to prevent lime scale build up. **DO NOT** use abrasive cleaning fluids or materials, or strong chemical cleaners as this will damage the product surface.