



**ROLECEV**

**ZURA**

Intelligent EV charging unit



Manufactured  
in the UK

# ZURA

Intelligent EV charging unit

Versatile, sophisticated and packed with the most-wanted smart features, along with never-seen-before customisable aesthetics. ZURA has been designed for both homes and businesses, providing up to 22kW superfast charging.

This OCPP compliant unit offers plug & charge or pay-to-charge solutions via a mobile app or RFID operation through any OCPP back-office management system.

This EV charger supports dynamic load balancing and is equipped with PME fault detection, with no requirement for an earth rod, reducing installation costs.

Available with single or dual outlets, making it ideal for businesses and households with more than one EV, or that are looking to future-proof. Domestic users can also charge using their solar PV or other home renewables for a zero-cost, zero-carbon charge.



**FREE app & support**

Domestic customers benefit from 3 years Monta app connectivity and support\*

\*Data fees may apply if connecting via 4G





# Product features

- Suitable for both domestic and commercial installations
- Plug & charge, mobile app or RFID controlled charging
- 1x or 2x universal charging socket(s) or Type 2 tethered lead(s)
- Up to 7.4kW or 22kW charging output(s)
- PME fault detection (no earth rod required)
- Dynamic load balancing (CT clamp & cable included\*)
- Solar PV, battery storage or wind turbine integration
- OCPP 1.6 compliant (can integrate with any back-office)
- Over-the-air firmware / software updates
- AC 30mA Type A & DC 6mA protection\*\*
- Dual tamper and breach security notifications
- Cable lock security feature (can be permanently locked by user)
- Integrated RFID reader
- MID-approved energy metering
- 4G / Wi-Fi / Ethernet connectivity
- IK08 impact resistant design
- Independent back plate for easy wall or post mounting
- OZEV grant fundable
- Designed & manufactured in the UK

Powered by  
**MONTA**

Other preferred back-office and mobile app partners:

**Fuuse**

**wattif**

**ChargePlace Scotland**  
electric vehicle charging

**ev.energy**



\*Single Phase models only, Three Phase models require optional CT kit ACSR0325

\*\*DC 6mA protection for single outlet models



## OCPP 1.6 compliant

Ability to integrate with any OCPP compliant back-office management system and app.



## Easy to operate

Three quick and easy ways to operate: mobile app, RFID cards and fobs or plug & charge.



## Eligible for grant funding

This chargepoint range is approved for OZEV grant funding schemes (subject to OZEV Ts & Cs).



## 4G / Wi-Fi / Ethernet enabled

Complete with secure 4G, Wi-Fi and Ethernet connectivity, ensuring chargers are always online 24/7.



## Branding & colour options available

Rolec offer a bespoke chargepoint branding service; from logos & brand colours, to vinyl wraps.



## No earth rod required

Equipped with built-in PME fault detection, saving on installation time and costs.

## The details

### UP TO 22KW

Available in both single phase and three phase models, providing up to 22kW superfast charging.

Choose from single or dual outlet models, allowing two vehicles to charge simultaneously. Single outlet units can be upgraded to dual in the future.\*

### CHARGE FOR FREE!

Sync your solar PV, battery storage or wind turbine setup to benefit from sustainable, zero-cost, zero-carbon charging.

Smart integration enabled, connect with your home energy management systems to optimise energy usage across your home.

### ACCURATE BILLING

Built-in MID-approved energy metering ensures accurate consumption reporting, which is essential for businesses and residential car parks, wishing to bill for their usage. Use our back-office management platform to generate revenue by setting your own tariffs.



### SAFE AND SECURE

Rest assured, Rolec's entire EV chargepoint range is fully UK Smart Charge Point Regulation compliant.

Over-the-air updates allow the chargers to receive the very latest features, ensuring a safe and future-proof product 24/7.

### 3 YEAR WARRANTY

Rolec EV chargepoints are designed, developed and manufactured in the UK and come with a 3 year warranty included as standard, for added peace of mind on your investment.

\*Single phase models only

# Specifications

## Product Overview:

	Connection Type	Charging Output	Input Supply	Fascia Colour	Product Code
Single Phase Units	1x Type 2 (IEC 62196) charging socket	Up to 7.4kW (32A)	1x Up to 32A Single Phase** 230V AC (±10 %) 50/60Hz	● Black	ROLEC3020B
	2x Type 2 (IEC 62196) charging sockets	Up to 7.4kW (32A) per socket	1x Up to 63A Single Phase** 230V AC (±10 %) 50/60Hz	● Black	ROLEC3030B
	1x Type 2 (IEC 62196) 5m tethered lead*	Up to 7.4kW (32A)	1x Up to 32A Single Phase** 230V AC (±10 %) 50/60Hz	● Black	ROLEC3140B
	2x Type 2 (IEC 62196) 5m tethered leads*	Up to 7.4kW (32A) per tethered lead	1x Up to 63A Single Phase** 230V AC (±10 %) 50/60Hz	● Black	ROLEC3150B
	1x Type 2 (IEC 62196) 10m tethered lead*	Up to 7.4kW (32A)	1x Up to 32A Single Phase** 230V AC (±10 %) 50/60Hz	● Black	ROLEC3145B
	2x Type 2 (IEC 62196) 10m tethered leads*	Up to 7.4kW (32A) per tethered lead	1x Up to 63A Single Phase** 230V AC (±10 %) 50/60Hz	● Black	ROLEC3155B
Three Phase Units	1x Type 2 (IEC 62196) charging socket	Up to 22kW (32A)	1x Up to 32A Three Phase** 400V AC (±10 %) 50/60Hz	● Black	ROLEC3046B
	1x Type 2 (IEC 62196) 5m tethered lead*	Up to 22kW (32A) per tethered lead	1x Up to 32A Three Phase** 400V AC (±10 %) 50/60Hz	● Black	ROLEC3156B

\*5m tethered leads (approx. 4.5m external) 10m tethered leads (approx. 9.5m external)

\*\*Chargepoint(s) will downrate if the input supply is lower than the maximum charging output.

Zura unit:

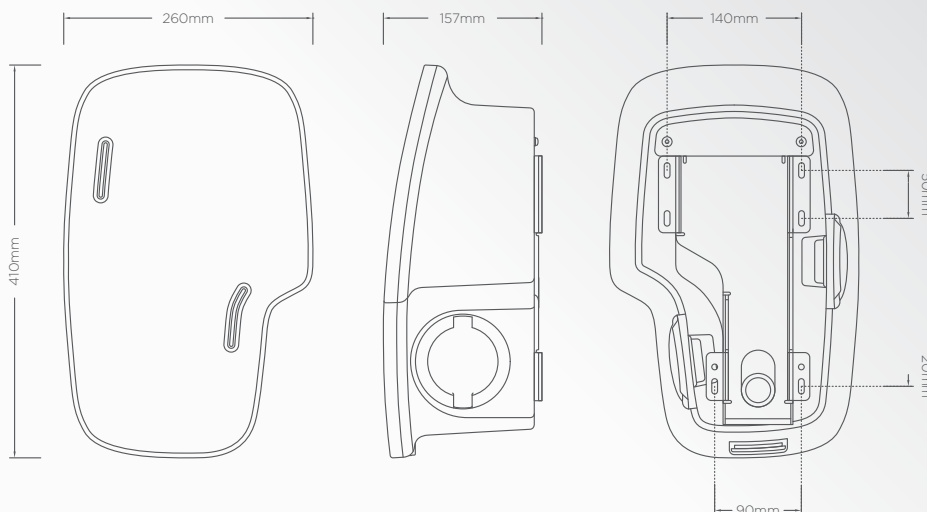



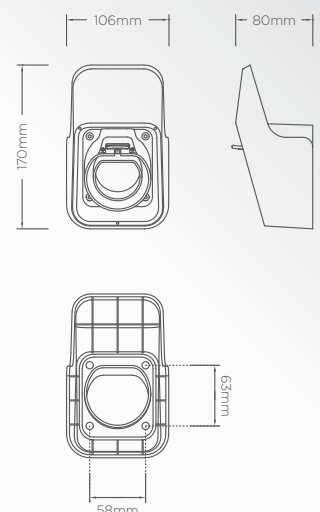

Type 2 charge gun holster:

Included with tethered units



# Specifications

## Technical Data:

<b>User Interface</b>	<ul style="list-style-type: none"> <li>• Mobile app</li> <li>• RFID reader (MIFARE ISO/IEC 14443 A)</li> <li>• Plug &amp; charge</li> <li>• RGB LED status indicator halo(s) – configurable</li> </ul>
<b>Charge Protocol</b>	Mode 3 (IEC 61851-1)
<b>Built-in Protection</b>	<ul style="list-style-type: none"> <li>• Models ROLEC3020 / ROLEC3140 / ROLEC3145: DC fault protection, 6mA</li> <li>• Models ROLEC3030 / ROLEC3046 / ROLEC3150 / ROLEC3155 / ROLEC3156: Residual current protection – AC 30mA Type-A &amp; DC 6mA</li> <li>• Lightning surge, over temperature protection</li> <li>• PME fault detection – No earth electrode/rod required</li> <li>• Supports automatic dynamic load balancing (may require additional hardware)</li> <li>• Supports static load management (software configurable)</li> </ul>
<b>Required External Protection</b>	<ul style="list-style-type: none"> <li>• Models ROLEC3020 / ROLEC3140 / ROLEC3145: AC overload &amp; fault current protection – A suitably rated 30mA Type-A RCBO or equivalent protection is required at source (dependent on cable type and/or route)</li> <li>• Models ROLEC3030 / ROLEC3046 / ROLEC3150 / ROLEC3155 / ROLEC3156: Over current protection – A suitably rated MCB or Type-A 30mA device is to be installed at source (dependent on cable type and/or route)</li> <li>• Surge Protection – May be required depending on the installation</li> </ul>
<b>Cable Terminals</b>	<ul style="list-style-type: none"> <li>• Single Phase – 3x 50mm 1P + N + E</li> <li>• Three Phase – 5x 50mm 3P + N + E</li> </ul>
<b>Communications</b>	<ul style="list-style-type: none"> <li>• 4G LTE Cat-1 (built-in nano SIM, subscription required) <ul style="list-style-type: none"> <li>• LTE FDD: B1/B3/B5/B7/B8/B20/B28</li> <li>• GSM: B2/B3/B5/B8</li> </ul> </li> <li>• Wi-Fi 802.11 b/g/n 2.4 GHz (2412-2472 MHz / 2422-2462 MHz)</li> <li>• NFC 13.56 MHz</li> <li>• RJ45 Ethernet connection</li> <li>• Bluetooth Low Energy (BLE 4.1) 2402-2480 MHz (for installer configuration purposes)</li> <li>• OCPP 1.6J</li> <li>• Cyber security – Data encryption level TLS 1.2</li> </ul>
<b>Energy Metering</b>	Integrated Class 1 MID compliant metering
<b>Standby Power Consumption</b>	< 7.5W (per outlet)
<b>Dimensions</b>	260mm x 410mm x 157mm (W x H x D)
<b>Weight</b>	< 5.5kg to < 13kg (model dependant)
<b>Environmental</b>	<ul style="list-style-type: none"> <li>• Ingress protection – Enclosure IP65, Socket IP54</li> <li>• Impact protection – IK08</li> <li>• Security – Dual tamper and breach protection boundaries with notifications</li> <li>• Operating temperature – -30°C to +50°C</li> <li>• Operating humidity – 5% to 95%</li> </ul>
<b>Materials</b>	<ul style="list-style-type: none"> <li>• Unit &amp; fascia – High impact resistant Polycarbonate</li> <li>• Mounting back plate – 1.5mm Steel with black powder coated finish</li> <li>• Rear bracket plate – 1.5mm 316 Stainless Steel</li> </ul>
<b>Unit Colour</b>	 Black
<b>Fascia Colour</b>	 Black  Grey  White  Branded or fully customised fascias available
<b>Certifications &amp; Compliances</b>	<ul style="list-style-type: none"> <li>• EV Charging Compliance – EN 61851-1:2019, EN 61851-22:2002</li> <li>• Smart Charge Points – (SI 2021/1467)</li> <li>• Wiring Regulations – BS 7671:2018+A2:2022</li> <li>• EMC Compliance – EN 61000-6-3:2007+A1:2011, EN 61000-6-2:2005, 2014/30/EU, SI 2016/1091</li> <li>• Safety Compliance (LVD) – EN 62368-1:2014, 2014/35/EU, SI 2016/1101</li> <li>• Communications / RED – EN 62311:2008, 2014/53/EU, SI 2017/1206, EN 300 330 V2.1.1 (2017-02), EN 301 908-1 V15.1.1 (2021-09), EN 301 908-13 V13.2.1 (2022-02), EN 301 511 V12.5.1 (2017-03), EN 300 328 V2.2.2 (2019-07), EN 300 440 V2.2.1 (2018-07)</li> <li>• Environmental Protection – BS EN 60529:1992+A2:2013</li> <li>• Impact Rating – BS EN 62262:2002+A1:2021</li> <li>• Metering – 2014/32/EU, SI 2016/1153</li> <li>• RoHS – 2011/65/EU, SI 2012/3032</li> <li>• REACH – 1907/2006, REACH etc. (Amendment) Regulations 2021</li> <li>• Certification Markings – CE &amp; UKCA</li> </ul>
<b>Warranty</b>	3 years



# Options & accessories

Product Code	Item Description
RFID0010	RFID card
RFID0020	RFID fob
EVFP0030	Mounting post - fits up to 2 chargers
EVCB0020	Root mount protection barrier - 48mm
EVCB0040	Surface mount protection barrier - 48mm
EVPS0010	EV parking sign - A4 landscape (Other sizes are available)
EVPP0100	5m 32A Type 2 to Type 2 charging cable
EVPP0107	10m 32A Type 2 to Type 2 charging cable
EVPP0105	5m 32A Three Phase Type 2 to Type 2 charging cable
EVPP0108	10m 32A Three Phase Type 2 to Type 2 charging cable (Other cables are available, including Type 1 options)
EVIN0010	20A Single Phase EV consumer unit with Type A RCBO
EVIN0015	40A Single Phase EV consumer unit with Type A RCBO
EVIN0070	20A Three Phase EV consumer unit with Type A RCBO
EVIN0075	40A Three Phase EV consumer unit with Type A RCBO
EVRS0030	Remote wall mount for Type 2 charge gun holster
ACSR0125	100A up to 35mm <sup>2</sup> screened CT clamp with 10m cable
ACSR0325	3x 100A up to 35mm <sup>2</sup> screened CT clamps with 10m cables
ZURA0100B	Zura EV charger front fascia plate - Black
ZURA0100G	Zura EV charger front fascia plate - Grey
ZURA0100W	Zura EV charger front fascia plate - White



EVIN0010



ACSR0125



EVPS0010



RFID0020



EVFP0030



EVPP0100



Brand names, logos and trademarks used herein remain the property of their respective owners. This listing of any firm or their logos is not intended to imply any endorsement or direct affiliation with Rolec Services Ltd. and is purely to demonstrate branding opportunities.

## Personalise your own charger















For those interested in customisation or aesthetics, this is the perfect solution for you. Whether it's your company branding, favourite place, colour or even an image of your pet, the choice is entirely yours. Contact Rolec for more information.





# Chargepoint management



Monta's chargepoint management platform provides businesses and organisations with the ability to deploy and self-manage their very own electric vehicle charging network. Ideal for workplace, fleet, commercial and residential locations.

-  Full & automated control of your chargepoints
-  Unlock additional revenue streams
-  Set chargepoints for public and/or private use
-  Set different pricing for individual chargepoints & groups
-  Dynamic pricing allows operators to set pricing in line with their hour-by-hour energy cost
-  Fully scalable solution; add or remove chargepoints & users
-  Complete fleet management solutions with analytical feedback & reporting
-  Reduce charging costs and CO<sub>2</sub> with Smart Charge feature
-  Vehicle integration provides visibility of battery size, SOC, percentage & location etc.
-  Automatically reimburse employees' home charging
-  Smart queuing system that sends notifications to drivers when they become available
-  Over-the-air updates and self-healing algorithms ensure charger stability & availability
-  Static, Dynamic or True Dynamic load balancing options
-  EV Roaming feature, allowing chargepoints to be available on other apps

Other preferred back-office partners:

-  Fuuse
-  wattif
-  ChargePlace Scotland  
electric vehicle charging

+ many more



**Charge point settings**  
Set charge point to public

Private  Public

**Reserve charge point**  
Book charge points at a time that suits you the best!

**Reserve**

**Easy payment for your employees**

  

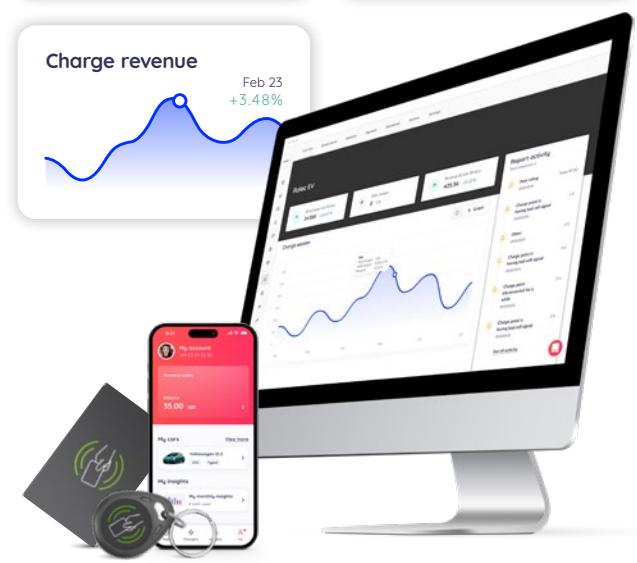
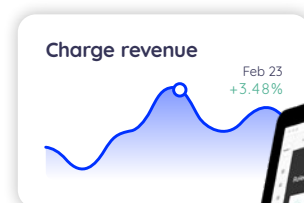

▶ For more information about Monta's chargepoint management solutions and pricing, see the Powered by Monta Overview Sheet



# Chargepoint operation

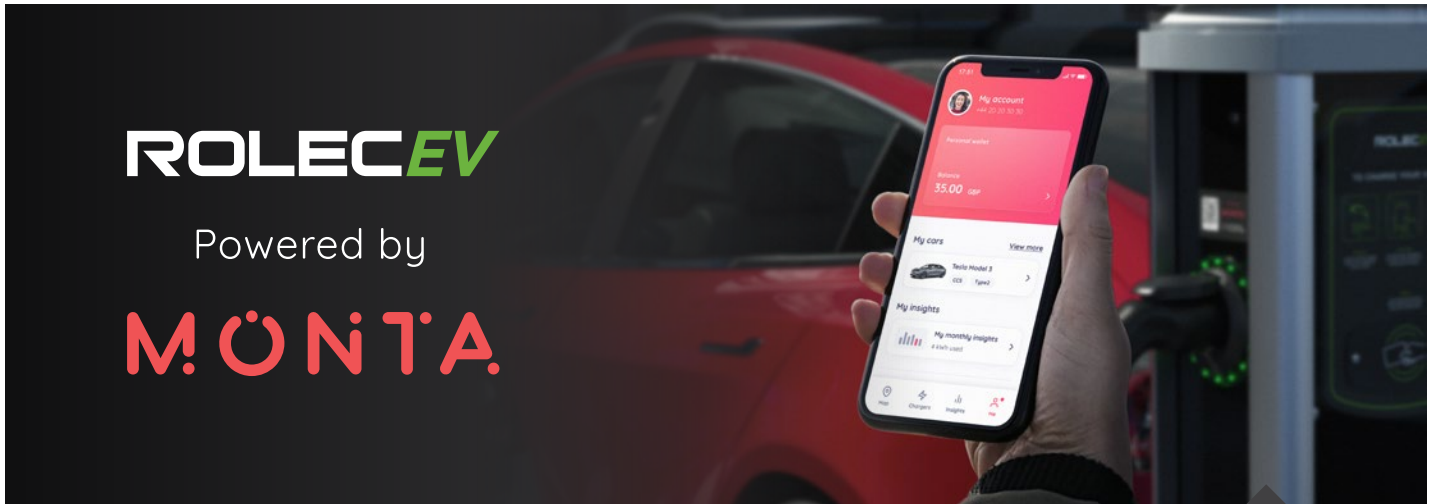

Charge your EV on your terms. With Monta you have full control over your charging experience, at home or on the road.

- Easily locate and navigate using the chargepoint map
- Remotely control your home EV charging
- Choose your ready time and choose to prioritise lower costs, lower CO<sub>2</sub> or only using renewable energy
- Schedule charges so your car is ready when you are
- Integrate with most EV manufacturer apps and cars
- Real-time information on your car and battery levels to maximize your charging experience
- Share and give charging access to friends, family and guests
- Set your home charger for public use with custom pricing
- Access to over 550,000 public chargepoints across Europe
- Easily initiate charging and complete payments via credit card, Apple Pay, Google Pay or Monta Wallet
- 24/7 online chat or email support for help when you need it most

The Monta app is 100% free with no subscription cost when charging at home

Other preferred mobile app partners:

- Fuuse
- wattif
- ChargePlace Scotland electric vehicle charging
- ev.energy



DOWNLOAD THE APP



## RFID activation

Great for quick activation, RFID cards or key fobs are easily accessible and add for a much simpler charging experience, which can also be used alongside the mobile app.



▶ For more details about the Monta solution for EV drivers and the Monta app, please visit [www.monta.com/uk/home-charging](http://www.monta.com/uk/home-charging)



THIS DOCUMENT CONTAINS INFORMATION THAT IS SUBJECT TO CHANGE WITHOUT NOTICE.

The latest version of this publication can be downloaded at <https://www.rolecserv.com/downloads-ev-charging>

Illustrations of the product and user interface are for marketing purposes only.

Brand names, logos and trademarks used herein remain the property of their respective owners. This listing of any firm or their logos is not intended to imply any endorsement or direct affiliation with Rolec Services Ltd. and is purely to demonstrate branding opportunities.

© 2024 by Rolec Services Ltd. All rights reserved.

EVZD-V03-RO Zura Data Sheet

---

**ROLECEV**

t: 01205 724754

e: [enquiries@rolecserv.co.uk](mailto:enquiries@rolecserv.co.uk)

[www.rolecserv.com](http://www.rolecserv.com)

