

ELCOT

Heated Towel Rail Installation Manual

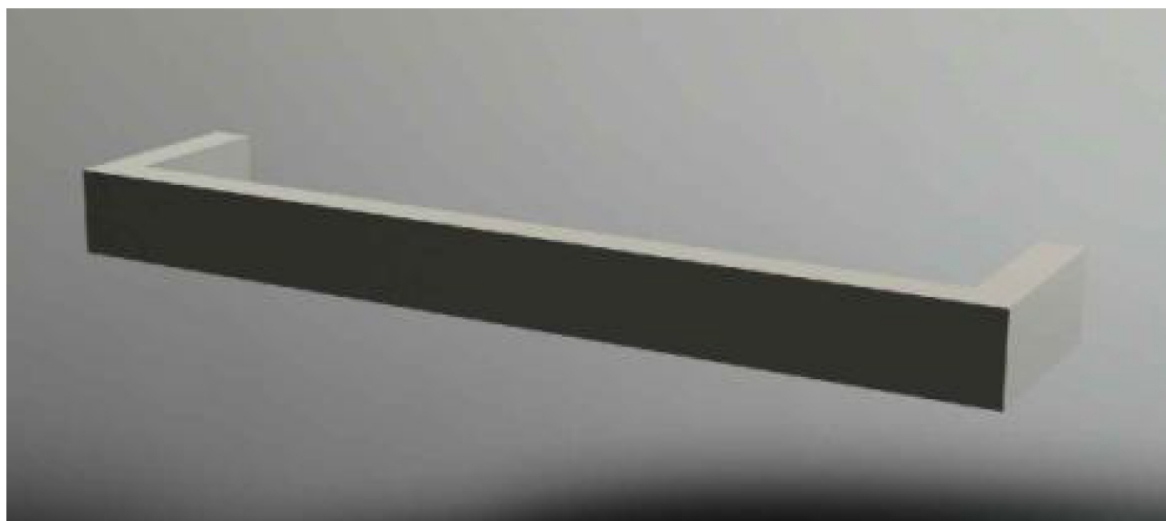

Finish	Product code	
	450 Wide	630 Wide
Chrome	488101	488109
Matt Black	488105	488111
Brushed Brass	488103	488108
Rose Gold	488106	488112
Polished Brass	488104	488110
Brushed	488100	488107

General Care and Safety Guide









Queensgate House, Cookham Road,
Bracknell, Berkshire, RG12 1RB
Tel 01628 625 367 Fax 01628 659 520
www.towelrads.com

Please read these instructions carefully before installing and operating the towel rail.

1. This Towel Rail is not intended for use by persons (including children) with reduced physical, sensory or mental capabilities, or lack of experience and knowledge, unless they have supervision or been instructed concerning use of the Towel Rail by a person responsible for their safety.
2. In order to avoid a hazard, this Towel Rail must be installed so that the bottom of the rail is at least 600mm above the floor.
3. This Towel Rail must be installed with a 12V transformer.
4. The distance from the transformer to the Towel Rail must be less than 2 metres.
5. This Towel Rail is intended to warm and dry towels and therefore will be hot to the touch when in operation.
6. The Towel Rail is to be installed so that the switches and other controls cannot be touched by a person in the bath or shower.
7. To avoid a hazard this Towel Rail must not be used to hold towels or any other articles that have been in contact with oil, petroleum based products or dry cleaning fluids.
8. Use this Towel Rail only with the voltage specified on the rating label.
9. Do not immerse in liquid or allow liquid to run into the interior of the Towel Rail.
10. Indoor use only.
11. Do not operate this Towel Rail if damaged or after the Towel Rail malfunctions or has been dropped or damaged in any manner. Return to a qualified electrician for examination, electrical service or repair.
12. Use this Towel Rail only as described in this manual. Any other use is not recommended by the manufacturer and may cause fire, electrical shock or injury.
13. Do not use this Towel Rail near a window as rain may cause electric shock.
14. When drilling walls, check first for hidden pipes and/or cables.
15. Please ensure that you wear all necessary personal protective equipment for your safety. When installing use safety eyewear when drilling.
16. Handle the product with care.
17. Keep small parts away from children.
18. Please check that all components are present and that you are happy with the size, design and finish before starting installation.

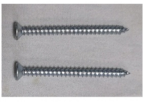
TOOLS REQUIRED (NOT SUPPLIED)

- Drill & Drill Bit
- Pencil
- Spirit Level
- Measuring Tape
- 12V Transformer

PACK CONTENTS		
2x Wall Anchors 	2x Wall Seat 	2x Screw 
1x Wire Terminal 	1x Allen Wrench 	1x 2 metres Wire 

TECHNICAL SPECIFICATION

Supply: 12VAC 50Hz
Wattage: 450 -17w, 630 - 23w
IP Rating: IP44

488101, 488105, 488103, 488106, 488104, 488100
450 x 40 x 100
488109, 488111, 488108, 488112, 488110, 488107
630 x 40 x 100

Installing your Towel Rail



TOWELRADS

Queensgate House, Cookham Road,
Bracknell, Berkshire, RG12 1RB
Tel 01628 625 367 Fax 01628 659 520
www.towelrads.com

Always choose a safe location for the Towel Rail, keeping in mind the safety precautions outlined. The transformer must be installed in a accessible and dry location.

WARNING: Installation must be completed by a qualified professional electrician in line with current electrical regulations and local standards.

Switch off mains power to ensure your safety before installing the Towel Rail.

This guide shows the installation of a single rail. Two or more rails can be installed together but must be wired in parallel to each other.

Pre-wiring in the wall cavity or ceiling is required.

Measure and mark out bracket positions, making sure they are level.

Fix mounting bracket.

Fix the mounting round base to the wall with screws. Ensure the wire from the wall reaches the connection from the rail.

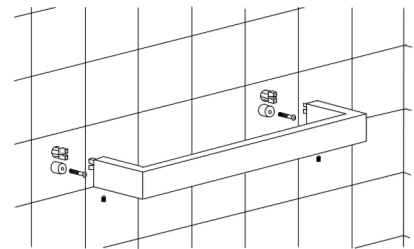

Fix the wire from the wall to the terminal from the Towel Rail.

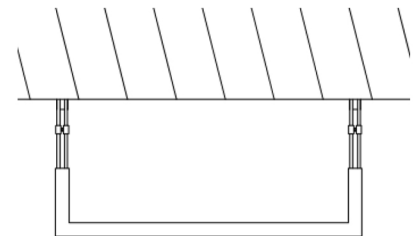

Fix the Towel Rail to the mounting base with hex screw at the bottom of the Towel Rail.

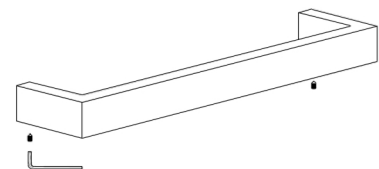

Operating your Towel Rail



TOWELRADS

Queensgate House, Cookham Road,
Bracknell, Berkshire, RG12 1RB
Tel 01628 625 367 Fax 01628 659 520
www.towelrads.com

WARNING: Installation must be completed by a qualified professional electrician.

ELECTRICIAN INFORMATION

A copy of this User Manual should be left with the purchaser.

Each 12V Towel Rail installation needs at least one 12V transformer.
The transformer must be located in a dry and accessible location.
Distance from the transformer to the Towel Rail must be less than 2 metres.

HEAT CONTROL

These Towel Rails run at a single temperature.
Please be aware they do get hot to the touch.

CAUTION: The Towel Rail generates heat during use. Proper precautions must be taken to prevent the risk of burns, scalds, fires or other damages to persons.

Do not attempt to dismantle the Towel Rail. there are no user serviceable parts. For service or repair, contact an authorised electrical service technician.

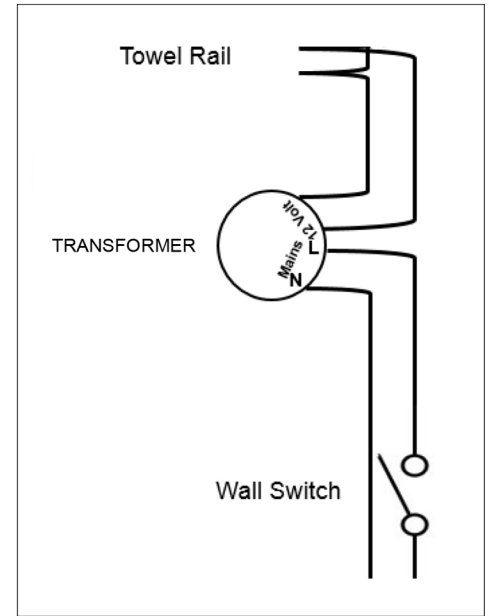

We have taken great care to ensure that this product reaches you in perfect condition. However should any parts be damaged or missing please contact your point of purchase. This does not affect your statutory rights.

WARRANTY:

Towel Rails are guaranteed for 3 years for manufacturing defects.

CARE AND MAINTENANCE

Regular cleaning with a soft cloth will keep the surface of your Towel Rail looking new. Soapy water can be used to remove stubborn stains and then buff dry with a soft cloth. Do not use abrasive or chemical cleaners to clean your Towel Rail as these will damage the surface over time.

