

# Operating instructions

for the system user

**VIESMANN**

- Room temperature controller, type UTDB
- Room temperature controller, type UTDB-RF, with wireless receiver IU300/ IU301-A10

## VITOTROL 100





## Safety instructions

### For your safety

 Please follow these safety instructions closely to prevent accidents and material losses.

#### Safety instructions explained

 **Danger**  
This symbol warns against the risk of injury.

 **Please note**  
This symbol warns against the risk of material losses and environmental pollution.

#### Note

*Details identified by the word "Note" contain additional information.*

#### Target group

These operating instructions are intended for heating system users.

This appliance can also be operated by children 8 years and older, as well as by individuals with reduced physical, sensory or mental faculties or those lacking in experience and knowledge, provided such individuals are being supervised or have been instructed in the safe use of this appliance and any risks arising from it.

 **Please note**  
Supervise children in the proximity of the appliance.

- Never permit children to play with the appliance.
- Cleaning and maintenance must not be carried out by unsupervised children.

#### Appliance connection

- The appliance may only be connected and commissioned by authorised contractors.
- Only operate the appliance with suitable fuels.
- Observe the specified electrical connection requirements.
- Modifications to the existing installation may only be carried out by authorised contractors.

 **Danger**  
Incorrectly executed work on the heating system can lead to life threatening accidents.

- Work on gas installations must only be carried out by a registered gas fitter.
- Work on electrical equipment must only be carried out by a qualified electrician.

#### Work on the appliance

- All settings and work on the appliance must be carried out as specified in these operating instructions. Further work on the appliance may only be carried out by authorised contractors.
- Never open the appliance.

- Never remove casings.
- Never change or remove attachments or fitted accessories.
- Never open or retighten pipe connections.

 **Danger**  
Hot surfaces can cause burns.

- Never open the appliance.
- Never touch the hot surfaces of uninsulated pipes, fittings or flue pipes.

#### Damage to the appliance

 **Danger**  
Damaged equipment poses a safety hazard. Check the appliance for external damage. Never start up a damaged appliance.

#### If you smell gas

 **Danger**  
Escaping gas can lead to explosions which may result in serious injury.

- Never smoke. Prevent naked flames and sparks. Never switch lights or electrical appliances on or off.
- Close the gas shut-off valve.
- Open windows and doors.
- Evacuate any people from the danger zone.
- Notify your gas and power supply utility and your local heating contractor from outside the building.
- Have the power supply to the building shut off from a safe place (outside the building).

#### If you smell flue gas

 **Danger**  
Flue gas can lead to life threatening poisoning.

- Shut down the heating system.
- Ventilate the installation site.
- Close all doors in the living space.

#### In case of fire

 **Danger**  
Fire presents a risk of burns and explosion.

- Shut down the heating system.
- Close the shut-off valves in the fuel supply lines.
- Use a tested fire extinguisher, class ABC.

**For your safety** (cont.)**In case of water leaking from the appliance****Danger**

Water leaking from the appliance poses an electrocution hazard.

- Switch off the heating system at the external isolation point (e.g. fuse box, domestic power distribution unit).
- Notify your local heating contractor.

**What to do if the heating system develops a fault****Danger**

Fault messages point to faults in the heating system. If faults are not rectified, they can have life threatening consequences.

Never acknowledge fault messages several times in quick succession. Inform your heating contractor so the cause can be analysed and the fault rectified.

**Installation room requirements****Danger**

Sealed vents result in a lack of combustion air. This leads to incomplete combustion and the formation of life threatening carbon monoxide. Never cover or close existing vents. Never make any subsequent modifications to the building characteristics that could affect safe operation (e.g. cable/pipework routing, cladding or partitions).

**Danger**

Easily flammable liquids and materials (e.g. naphtha, solvents, cleaning agents, paints or paper) can cause deflagration and fire. Never store or use such materials in the installation room or in direct proximity to the heating system.

**Please note**

Incorrect ambient conditions can lead to heating system damage and can put safe operation at risk.

- Ensure ambient temperatures are above 0 °C and below 35 °C.
- Prevent air contamination by halogenated hydrocarbons (e.g. as contained in paints, solvents or cleaning fluids) and excessive dust (e.g. through grinding/polishing work).
- Avoid continuously high humidity levels (e.g. through continuous drying of washing).

**Extractors**

The operation of appliances that extract air to the outside (cooker hoods, extractors, air conditioning units, etc.) can create negative pressure. If the boiler is operated at the same time, this can lead to a reverse flow of the flue gas.

**Danger**

The simultaneous operation of the boiler and appliances that extract air to the outside can result in life threatening poisoning due to reverse flow of the flue gas.









Take suitable steps to ensure an adequate supply of combustion air. If necessary, contact your heating contractor.

**Auxiliary components, spare and wearing parts****Please note**

Components not tested with the heating system may damage the system or affect its function. Have all installation or replacement work carried out exclusively by qualified contractors.

<b>1. Information</b>	Symbols .....	5
	Intended use .....	5
	Product information .....	5
	Commissioning .....	6
	Energy saving tips .....	6
	Tips for greater comfort .....	6
<b>2. Operation</b>	Summary of controls and indicators .....	7
	■ Opening the flap .....	7
	■ Functions .....	7
	■ Symbols on the display .....	8
	How to use the controls .....	8
	■ Default display .....	8
	■ Operating display .....	8
	■ Display illumination .....	8
	■ Locking the controls .....	9
<b>3. Central heating</b>	Selecting the operating mode .....	10
	■ Selecting a time program for heating mode .....	10
	■ Time programs in the delivered condition .....	10
	■ Changing the time phases of the time programs .....	11
	■ Frost protection mode .....	12
	■ Operation with constant room temperature (manual) .....	12
	Setting a permanent room temperature .....	13
	■ .....	13
	Changing the room temperature for a few days only .....	13
	■ Setting a holiday program .....	13
	Changing the room temperature for a few hours only .....	14
	■ Using ▲/▼ to make adjustments .....	14
	■ Setting party mode .....	14
	■ Setting economy mode .....	14
<b>4. Further adjustments</b>	Time and date .....	15
	Summertime/wintertime .....	15
	Setting the language .....	15
	Renaming time programs .....	15
	Temperature balancing .....	16
	Control characteristics .....	16
<b>5. Calling up information</b>	Scanning temperatures and further settings .....	17
	Scanning time programs .....	17
	Calling up the holiday program (if set) .....	17
<b>6. What to do if...</b>	Rooms are too cold .....	18
	Rooms are too hot .....	18
	🔋 flashes on the display .....	18
	Replacing the batteries .....	18
	■ Reset .....	19
	Changing the address code .....	19
<b>7. Maintenance</b>	Cleaning .....	21
<b>8. Certificates</b>	Declaration of Conformity .....	22
<b>9. Keyword index</b>	.....	23

## Symbols

Symbol	Meaning
	Reference to other document containing further information
	Step in a diagram: The numbers correspond to the order in which the steps are carried out.
	Warning of material losses and environmental pollution
	Live electrical area
	Pay particular attention.
	<ul style="list-style-type: none"> <li>▪ Component must audibly click into place.</li> <li>or</li> <li>▪ Acoustic signal</li> </ul>
	<ul style="list-style-type: none"> <li>▪ Fit new component.</li> <li>or</li> <li>▪ In conjunction with a tool: Clean the surface.</li> </ul>
	Dispose of component correctly.
	Dispose of component at a suitable collection point. Do <b>not</b> dispose of component in domestic waste.

## Intended use

Install and operate the appliance as intended, in conjunction with the electronic control units and controllers for the Viessmann heat and power generators designed for this system. Also take account of the relevant installation, service and operating instructions. In particular, observe the current and voltage specifications for connections and hook-ups.

The device is exclusively designed for operation in buildings of a domestic or commercial nature.

Incorrect usage or operation of the appliance (e.g. the appliance being opened by the system user) is prohibited and will result in an exclusion of liability. Incorrect usage also occurs if the components in the heating system are modified from their intended function.

### Note

*The appliance is intended exclusively for domestic or semi-domestic use, i.e. even users who have not had any instruction are able to operate the appliance safely.*

## Product information

The Vitotrol 100, type UTDB is a battery powered room temperature controller with switching output.

### Product information (cont.)

The Vitotrol 100, type UTDB-RF is a battery powered room temperature controller with switching output, integral wireless transmitter and separate wireless receiver.

The digital time switch provides the option to use time programs for central heating.

### Commissioning

Your room temperature controller is ready for operation and is connected to the Vitotronic control unit of the boiler.

The commissioning and adjusting of the Vitotronic control unit to the local conditions and building characteristics must be carried out by your heating contractor. He must also provide instruction in operating the system.

### Energy saving tips

#### Central heating

- **Standard room temperature** (see page 13):  
Do not overheat your home. Every degree of room temperature reduction saves up to 6 % on your heating bills.
- **Time program** (see page 10):  
Heat your home to the standard room temperature during the day and the reduced temperature at night. Set this via the time program.
- **Short absence** (see page 14):  
Reduce the room temperature if you are going out shopping, for example. For this, select "**Economy mode**".
- **Holidays** (see page 13):  
If you are going away, select the "**Holiday program**":  
The room temperature is reduced, and DHW heating is turned off.

- **Airing:**  
Close the thermostatic valves when airing. Open the windows fully for a brief time.
- **Roller shutters:**  
Close roller shutters (if installed) at dusk.
- **Thermostatic valves:**  
Ensure that thermostatic valves are properly adjusted.
- **Radiators:**  
Never cover radiators or thermostatic valves.

For additional energy saving functions of the Vitotronic control unit, please contact your heating contractor.

### Tips for greater comfort

#### Central heating

- **Time program** (see page 10):  
Make use of the time program. In the time program, you can set time phases with different room temperatures, for example different temperatures for day and night time.
- **"Party mode"** (see page 14):  
If you want to heat rooms to a different temperature from the one set in the time program, select "**Party mode**".  
Example: Due to the time program settings, your home is heated to a reduced room temperature during late evening, but you have visitors staying late.

## Summary of controls and indicators

### Opening the flap

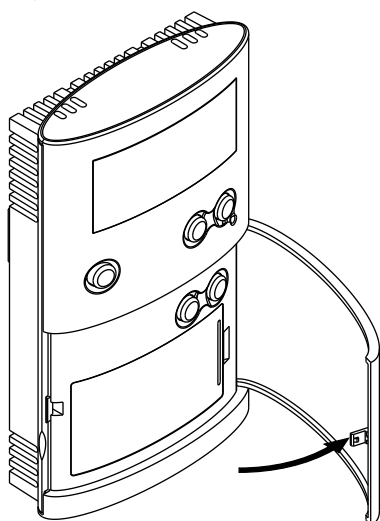

Fig. 1

### Functions

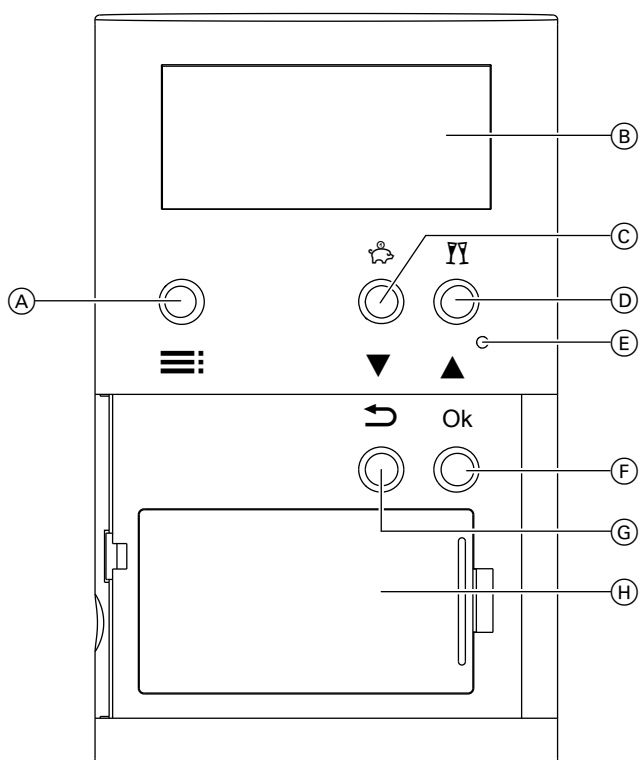

Fig. 2

- (A) To call up the menu.
- (B) Display
- (C) To activate economy mode ❄️ (page 14) or to adjust values ▼.
- (D) To activate party mode YY (page 14) or to adjust values ▲.
- (E) Reset
- (F) To confirm your selection or save the setting you've made.
- (G) To go back one step in the menu or to cancel a setting that has been started.
- (H) Battery compartment

## Summary of controls and indicators (cont.)

### Symbols on the display

These symbols are not always displayed, but appear subject to operating conditions.

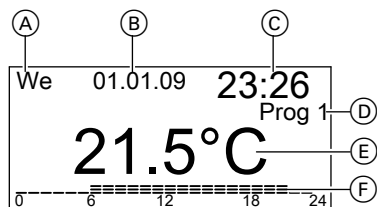

Fig. 3

- (A) Day of the week
- (B) Date
- (C) Time
- (D) Selected time program
- (E) Room temperature
- (F) Time program shown as time slot graphic

- Heat demand
- Party mode active
- Economy mode active
- Manual mode active
- Holiday program active
- Frost protection mode active
- Replace battery
- Controls locked

## How to use the controls

### Default display

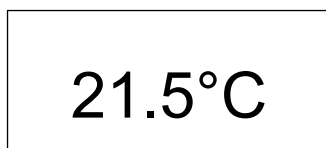

Fig. 4

Press key : or :  
The display illumination is activated and you are taken to the operating display.

### Operating display

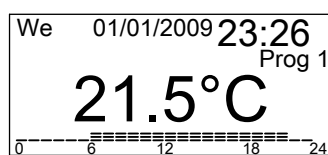

Fig. 5

1. If the display illumination has gone out, press key :  
The display illumination is activated.
2. If the display illumination is activated, press key again:  
This will take you to the menu.

3. Use / to make the required settings and confirm them with **OK**. Temperature changes made with / are accepted automatically after 5 s.

#### Note

The menu is automatically exited approx. 30 s after the last key was pressed.

### Display illumination

Press any key to activate the display illumination. The display illumination automatically switches off approx. 15 s after the last key was pressed.



**How to use the controls** (cont.)**Locking the controls**

You can lock the control keys of the Vitotrol 100. To do so, press ▼ and ▲ simultaneously for 5 s. To unlock the keys, again press ▼ and ▲ simultaneously for 5 s.

## Central heating

### Selecting the operating mode

You can select between the following operating modes:

- Heating mode in accordance with the time program:  
See page 10
- Frost protection mode: See page 12
- Operation with constant room temperature (manual):  
See page 12

### Selecting a time program for heating mode



You can choose from 3 preset time programs (Prog 1 to Prog 3).

You can change the preset time programs in accordance with your individual requirements.

Within each time program, you can change between 3 room temperatures:

- Comfort (factory setting: 21 °C)
- Eco (factory setting: 19 °C)
- Reduced (factory setting: 16 °C)

You can change the set values for the room temperatures: See page 13.

1. Open the flap.
2. Press  twice.
3. Use / to select the required time program. (e.g. "**Prog 1**").
4. Confirm with **OK**.  
Heating mode operates according to the selected time program.

### Time programs in the delivered condition

#### Time program 1 – Prog 1

##### Monday to Friday

Time phase	Start	End	Room temperature
1	06:00	08:00	Comfort
2	08:00	12:00	Comfort
3	12:00	14:00	Comfort
4	14:00	18:00	Comfort
5	18:00	22:00	Comfort
6	22:00	06:00	Reduced

##### Saturday and Sunday

Time phase	Start	End	Room temperature
1	07:00	08:00	Comfort
2	08:00	12:00	Comfort
3	12:00	14:00	Comfort
4	14:00	16:00	Comfort
5	16:00	23:00	Comfort
6	23:00	07:00	Reduced

#### Time program 2 – Prog 2

##### Monday to Friday

Time phase	Start	End	Room temperature
1	06:00	08:00	Comfort
2	08:00	12:00	Reduced
3	12:00	14:00	Reduced
4	14:00	16:00	Reduced

## Selecting the operating mode (cont.)

Time phase	Start	End	Room temperature
5	16:00	22:00	Comfort
6	22:00	06:00	Reduced

### Saturday and Sunday

Time phase	Start	End	Room temperature
1	07:00	08:00	Comfort
2	08:00	12:00	Comfort
3	12:00	14:00	Comfort
4	14:00	18:00	Comfort
5	18:00	23:00	Comfort
6	23:00	07:00	Reduced

### Time program 3 – Prog 3

#### Monday to Friday

Time phase	Start	End	Room temperature
1	06:00	08:00	Comfort
2	08:00	12:00	Eco
3	12:00	14:00	Comfort
4	14:00	18:00	Eco
5	18:00	23:00	Comfort
6	23:00	06:00	Reduced

#### Saturday and Sunday

Time phase	Start	End	Room temperature
1	07:00	08:00	Comfort
2	08:00	12:00	Comfort
3	12:00	14:00	Comfort
4	14:00	18:00	Comfort
5	18:00	23:00	Comfort
6	23:00	07:00	Reduced

## Changing the time phases of the time programs

In the delivered condition, the day is split into 6 time phases.

You can also split the day into less than 6 time phases, for example:

- Time phase 1: Operation with standard room temperature from 06:00 to 22:00 h and
- Time phase 2: Operation with reduced room temperature from 22:00 to 06:00 h

After entry, the last time phase is automatically assigned to time phase 6. The other time phases are then disabled.

Enter a start time, stop time and a room temperature for each active time phase ("**Comfort**", "**Eco**", "**Reduced**") (see example).

You can select time phases for several days (day groups) or for individual days:

- "**MO-SU**" for the same time phases on every day of the week
- "**MO-FR**" for the same time phases on Monday to Friday
- "**SA-SU**" for the same time phases on Saturday and Sunday
- "**SINGLE DAY**" for different time phases on individual days

#### Note

*Settings for individual days take priority over settings for several days.*

1. Open the flap.
2. Press  twice.

### Selecting the operating mode (cont.)

3. Use ▲/▼ to select **"Settings"**.
4. Confirm with **OK**.
5. Use ▲/▼ to select **"Programs"**.
6. Confirm with **OK**.
7. Use ▲/▼ to select the program you want to change (e.g. **"Prog 1"**).
8. Confirm with **OK**.
9. Use ▲/▼ to select **"Set"**.
10. Confirm with **OK**.
11. Use ▲/▼ to select the required group of days/single day.
12. Confirm with **OK**.
13. Use ▲/▼ to select the required time phase, or first the required day.
14. Use ▲/▼ to set the required start time, stop time and room temperature (e.g. **"Reduced"**) in succession.
15. Confirm each respectively with **OK**.
16. Proceed as described in points 11 to 13 to set further time phases.

#### Note

*If the settings create gaps between the time phases, these are closed automatically by extending the preceding time phase.*

### Deactivating time phases

To deactivate a time phase, set the same value for the start and the stop time.

### Copying time programs

You can copy time programs, for example if you want to create a new time program based on an existing one with only minor differences.

1. Open the flap.
2. Press ≡: twice.
3. Use ▲/▼ to select **"Settings"**.
4. Confirm with **OK**.
5. Use ▲/▼ to select **"Programs"**.
6. Confirm with **OK**.
7. Use ▲/▼ to select the program you want to change (e.g. **"Prog 1"**).
8. Confirm with **OK**.
9. Use ▲/▼ to select **"Copy from"**.
10. Confirm with **OK**.
11. Use ▲/▼ to select the program you want to copy.
12. Confirm with **OK**.
13. Use ▲/▼ to select **"Set"**, to make the changes.

### Frost protection mode

If you do not want to heat the interior but would like to have frost protection.

If the room temperature falls below 5 °C, central heating starts.

1. Open the flap.
2. Press ≡: twice.
3. Use ▲/▼ to select **"Frost pr."**
4. Confirm with **OK**.  
The display shows ❄ and the current room temperature.

### Operation with constant room temperature (manual)

Continuous central heating with the set temperature

1. Open the flap.
2. Press ≡: twice.
3. Use ▲/▼ to select **"Manual"**.
4. Confirm with **OK**.
5. Use ▲/▼ to set the required room temperature (min. 10 °C).

## Selecting the operating mode (cont.)



- Confirm with **OK**.  
The display shows  and again the current room temperature.





## Setting a permanent room temperature

You can set 3 room temperatures:

- Standard room temperature **"Comfort"**  
Factory setting: 21 °C  
Setting range: 10 to 40 °C
- Room temperature **"Eco"**  
Factory setting: 19 °C  
Setting range: 10 to 40 °C
- Reduced room temperature **"Reduced"**  
Factory setting: 16 °C  
Setting range: 10 to 40 °C



The rooms are heated to one of the 3 room temperatures, in accordance with the active time phase of the selected time program.

- Open the flap.
- Press  twice.
- Use  to select **"Settings"**.





- Confirm with **OK**.
- Use  to select **"Tmp settings"**.
- Confirm with **OK**.
- Use  to set the required temperature for **"Comfort"**.
- Confirm with **OK**.
- Use  to set the required temperature for **"Eco"**.
- Confirm with **OK**.
- Use  to set the required temperature for **"Reduced"**.
- Confirm with **OK**.

## Changing the room temperature for a few days only

The following energy saving options are available for times when you are on holiday:

- You can shut central heating down completely by selecting frost protection mode .
- or
- You can set the central heating to minimum energy consumption (e.g. to prevent your house plants from being damaged by the cold). To do so, select the holiday program . If the holiday program is active, the rooms are heated to the reduced room temperature (**"Reduced"**).



### Setting a holiday program

- Open the flap.
- Press  twice.
- Use  to select **"Holiday"**.
- Confirm with **OK**.
- Use  to select **"ON"**.
- Confirm with **OK**.
- Use  to select the required day and time for the starting and ending of the holiday function.

- Confirm each respectively with **OK**.

### Terminating the holiday program

- The holiday program terminates automatically when the end time has been reached.
- If you want to terminate the holiday program early:

- Open the flap.
- Press  twice.
- Use  to select **"Holiday"**.
- Confirm with **OK**.

### Changing the room temperature for a few days... (cont.)

5. Use ▲/▼ to select "OFF".

### Changing the room temperature for a few hours only

The following functions enable you to change the room temperature for a few hours without permanently altering your settings.

The modified room temperature remains enabled until the next changeover within a program or until the next switch to a different program.

If you want an unscheduled increase in room temperature:

- In programs "Prog 1" to "Prog 3" and "Manual", you can increase the room temperature with ▲.
- or
- In programs "Prog 1" to "Prog 3", select party mode by pressing .

If you want an unscheduled reduction in room temperature:



- In programs "Prog 1" to "Prog 3" and "Manual", you can lower the room temperature with ▼.
- or
- In programs "Prog 1" to "Prog 3", select economy mode by pressing .

### Using ▲/▼ to make adjustments

1. Press ▼ or ▲.  
The current set room temperature is displayed.
2. Use ▲/▼ to set the required temperature.
3. Confirm with **OK** or wait approx. 5 s until the value is adopted automatically.

### Setting party mode

In party mode, the reduced room temperature is automatically set to 21 °C.

1. Press  for approx. 5 s.  
The display shows .
2. Use ▲/▼ to set the room temperature for party mode.

3. Confirm with **OK**.

### Ending party mode



- Party mode ends automatically at changeover to the next time phase of the time program.
- Press  again for approx. 5 s if you want to terminate party mode early.

### Setting economy mode

In economy mode, the set room temperature is automatically reduced.

You can set economy mode during reduced mode "Eco" and "Reduced".

The lowest room temperature in economy mode is 10 °C.

1. Press  for approx. 5 s.  
The display shows .
2. Use ▲/▼ to set the room temperature for economy mode.
3. Confirm with **OK**.

### Ending economy mode

- Economy mode ends automatically at changeover to the next time phase of the time program.
- Press  again for approx. 5 s if you want to terminate economy mode early.

## Time and date

1. Open the flap.
2. Press **≡**: twice.
3. Use **▲/▼** to select **"Settings"**.
4. Confirm with **OK**.
5. Use **▲/▼** to select **"Standard settings"**.
6. Confirm with **OK**.
7. Use **▲/▼** to select **"Date - time"**.
8. Confirm with **OK**.
9. Use **▲/▼** to set the current date and time.
10. Confirm each respectively with **OK**.

## Summertime/wintertime

The changeover from summertime to wintertime and vice-versa is automatic. You can stop this automatic changeover.

1. As described on page 15, select **"Date - time"**.
2. Use **OK** to select **"Summertime ON"**.
3. Use **▲/▼** to select **"OFF"**.
4. Confirm with **OK**.

## Setting the language

1. Open the flap.
2. Press **≡**: twice.
3. Use **▲/▼** to select **"Settings"**.
4. Confirm with **OK**.
5. Use **▲/▼** to select **"Standard settings"**.
6. Confirm with **OK**.
7. Use **▲/▼** to select **"Language"**.
8. Confirm with **OK**.
9. Use **▲/▼** to select the required language.
10. Confirm with **OK**.

## Renaming time programs

You can individually rename programs **"Prog 1"** to **"Prog 3"**. The designation is limited to 5 characters.

1. Open the flap.
2. Press **≡**: twice.
3. Use **▲/▼** to select **"Settings"**.
4. Confirm with **OK**.
5. Use **▲/▼** to select **"Programs"**.
6. Confirm with **OK**.
7. Use **▲/▼** to select the program you want to rename (e.g. **"Prog 1"**).
8. Confirm with **OK**.
9. Use **▲/▼** to select **"Rename"**.
10. Confirm with **OK**.
11. Use **▲/▼** to enter the required characters on line **"New name"**.
12. Confirm each respectively with **OK**.





## Further adjustments

### Temperature balancing

If your Vitotrol 100 is installed in an unfavourable position, e.g. on an external wall or near an open fireplace, the displayed room temperature can deviate from the actual room temperature. You can compensate for this temperature deviation with a correction value.

**Example:**

The room temperature displayed by the Vitotrol 100 is 2 °C higher than the actual room temperature. The correction value is then -2 °C.

1. Open the flap.
2. Press  twice.
3. Use  to select "**Settings**".
4. Confirm with **OK**.
5. Use  to select "**Service**".
6. Confirm with **OK**.
7. Use **OK** to select the required value to be set for "**Ctrlrler offset**".
8. Use  to set the required value.
9. Confirm with **OK**.
10. Only for the Vitotrol 100, type UTDB-RF:  
Exit the menu with .

### Control characteristics

The hysteresis controller is factory-set. The hysteresis value influences the start and stop times for "Heating" or "Not heating".





**Example:**

Set room temperature: 21 °C

Hysteresis: 0.6 °C (factory setting)

As soon as the actual room temperature exceeds 21.3 °C, heating is stopped. Heating starts as soon as the actual room temperature falls below 20.7 °C.

You can change the control characteristics by changing the hysteresis value. Select a lower value if your system responds too slowly.

1. Open the flap.
2. Press  twice.
3. Use  to select "**Settings**".
4. Confirm with **OK**.
5. Use  to select "**Service**".
6. Confirm with **OK**.
7. Use  to set the required hysteresis value.
8. Confirm 2 times with **OK**.
9. Only for the Vitotrol 100, type UTDB-RF:  
Exit the menu with .



## Scanning temperatures and further settings

1. Press **≡**:

The display shows the following details:

- Room temperature
- Date and time
- Current program
- Day of the week

2. Use **▲/▼** to call up the current set temperature.

## Scanning time programs

On the display, you see the selected time program Prog 1, Prog 2 or Prog 3. The time phases of the current day are shown in a time slot graphic.

**Example:**

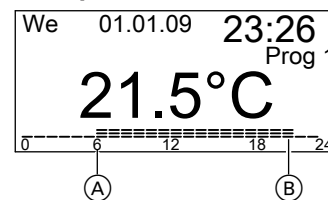

Fig. 6

Central heating will operate from 06:00 (A) to 22:00 h (B) with standard room temperature and from 22:00 to 06:00 h with reduced room temperature.

## Calling up the holiday program (if set)

1. Open the flap.
2. Press **≡** twice.
3. Use **▲/▼** to select "**Holiday**".
4. Confirm with **OK**.  
Start and end of the set holiday period are displayed.

## What to do if...

### Rooms are too cold

Cause	Remedy
The Vitotrol 100 is set incorrectly.	Check the settings and correct if required: <ul style="list-style-type: none"><li>▪ Time program for heating mode (see page 10)</li><li>▪ Room temperature (see page 13)</li><li>▪ Time (see page 15)</li></ul>
The wireless connection to the boiler control unit is interrupted (only for Vitotrol 100, type UTDB-RF with wireless connection). At the receiver unit, the display  flashes.	Change the address code (see page 19).

#### Note

For further causes, see the boiler operating instructions

### Rooms are too hot

Cause	Remedy
The Vitotrol 100 is incorrectly set.	Check the settings and correct if required: <ul style="list-style-type: none"><li>▪ Time program (see page 10)</li><li>▪ Room temperature (see page 13)</li><li>▪ Time (see page 15)</li></ul>

#### Note

For further causes, see the boiler operating instructions

### flashes on the display

Cause	Remedy
The batteries are spent.	Change the batteries (see page 18). <b>Disposal:</b> Batteries should not be disposed of in domestic waste. Always dispose of spent batteries via an authorised collection site.

### Replacing the batteries

- Use only alkaline batteries, 1.5 V Mignon alkaline cells, type LR6/AA that do not contain hazardous substances.
- Never use rechargeable batteries.
- Replace **both** batteries every 18 months.

## Replacing the batteries (cont.)

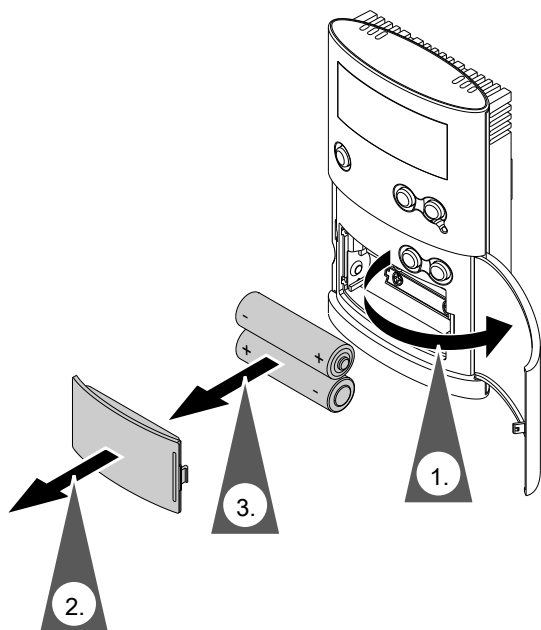

Fig. 7

The Vitotrol 100 has a power reserve of 3 min. If you replace the batteries within this time, all set data is retained. If the power reserve has been exceeded, a reset will need to be carried out (see next chapter).

## Reset

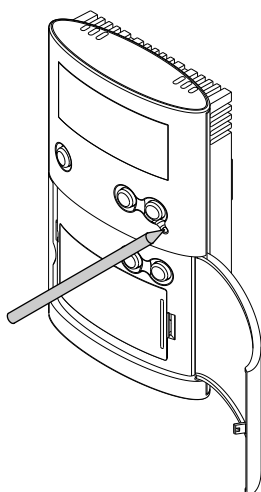

Fig. 8

Press the reset button with a suitable instrument. After a reset, the language, time and date will need to be set anew.

## Changing the address code



Only for the Vitotrol 100, type UTDB-RF, if flashes on the wireless receiver.

1. Press on the wireless receiver for approx. 10 s until flashes.
2. Open the flap on the Vitotrol 100.
3. Press twice.
4. Use to select "Settings".
5. Confirm with **OK**.
6. Use to select "Service".
7. Confirm 3 times with **OK**.
8. Use to select "Address code".

## Changing the address code (cont.)

**9. Confirm with OK.**

The display shows a number combination for approx. 30 s. Then **"Send data"** appears on the display. The transfer takes 30 s.  flashes during the transfer.

If the receiver recognises the address code,  and  go out. If the address code is not recognised, repeat the process from point 3.

## Cleaning

This device can be cleaned with a commercially available domestic cleaning agent (non-scouring).

## Declaration of Conformity

### Vitotrol 100, type UTDB

### Vitotrol 100, type UTDB-RF with wireless receiver IU300/IU301-A10

We, Viessmann Werke GmbH & Co. KG, D-35107 Allendorf, declare as sole responsible body that the listed products comply with the provisions of the following directives:

1999/5/EEC R&TTE Directive

2004/108/EEC EMC Directive

2006/95/EEC Low Voltage Directive

2011/65/EEC RoHS II

In accordance with the provisions of these Directives, these products are  designated.

#### Applied standards:

EN 60730-1: 2011

EN 60730-2-9: 2010

EN 55014-1: 2006+A1: 2009+A2: 2011

EN 55014-2: 1997+A1: 2001+A2: 2008

ETSI EN 301 489-1 (V1.9.2): 2011

ETSI EN 301 489-3 (V1.6.1): 2013

ETSI EN 300220-2 (V2.4.1): 2012

ETSI EN 300220-1 (V2.4.1): 2012

EN 62479: 2010

Allendorf, 01 October 2015

Viessmann Werke GmbH & Co. KG



Authorised signatory Manfred Sommer

**Keyword index**

<b>C</b>		<b>L</b>	
Calling up time programs.....	17	Language.....	15
Central heating		<b>M</b>	
– Saving energy.....	6	Maintenance.....	21
Changing the room temperature		<b>P</b>	
– For a few days.....	13	Party mode.....	7
– For a few hours.....	14	Product information.....	5
Cleaning.....	21	Program name.....	15
Comfort (tips).....	6	<b>S</b>	
Commissioning.....	6	Saving energy.....	14
Compensating temperature deviations.....	16	Setting economy mode.....	14
Control and display elements.....	7	Setting party mode.....	14
Control characteristics.....	16	Settings	
<b>D</b>		– Scanning.....	17
Declaration of Conformity.....	22	Setting the room temperature.....	13
<b>E</b>		<b>T</b>	
Economy mode.....	7	Temperature balancing.....	16
Energy saving.....	13	Temperatures	
Energy saving (tips).....	6	– Changing temporarily.....	14
<b>H</b>		– Scanning.....	17
Holiday.....	13	Time and date.....	15
Holiday program		Time phases of the time programs	
– Calling up.....	17	– Changing.....	11
– Setting.....	13	Tips	
– Terminating.....	13	– Comfort.....	6
<b>I</b>		– Energy saving.....	6
Information.....	5	Troubleshooting.....	18
Intended use.....	5		

## Certification

**RoHS**  
compliant  
2002 / 95 / EC

## Your contact

Contact your local contractor if you have any questions regarding the maintenance and repair of your system. You may, for example, find local contractors on the internet under [www.viessmann.com](http://www.viessmann.com).

Viessmann Werke GmbH & Co. KG  
D-35107 Allendorf  
Telephone: +49 6452 70-0  
Fax: +49 6452 70-2780  
[www.viessmann.com](http://www.viessmann.com)

Viessmann Limited  
Hortonwood 30, Telford  
Shropshire, TF1 7YP, GB  
Telephone: +44 1952 675000  
Fax: +44 1952 675040  
E-mail: [info-uk@viessmann.com](mailto:info-uk@viessmann.com)

5592 618 GB Subject to technical modifications.